

APRIL, 1926

25 CENTS

RADIO

(Mag. U. S. Patent Off.)



Cunningham

RADIO TUBES



Confidence in a Name

KNOWLEDGE derived from his own experience soon convinces the radio recruit that all radio tubes are *not* alike--no matter how similar their appearance. And from his own experience he

reaches the conclusion of millions --that the best guarantee of hidden value and unseen protection in a radio tube is in the name Cunningham with a reputation zealously guarded since 1915.

E. J. Cunningham Inc.

Chicago

San Francisco

New York

REG. U.S.
PAT. OFF.

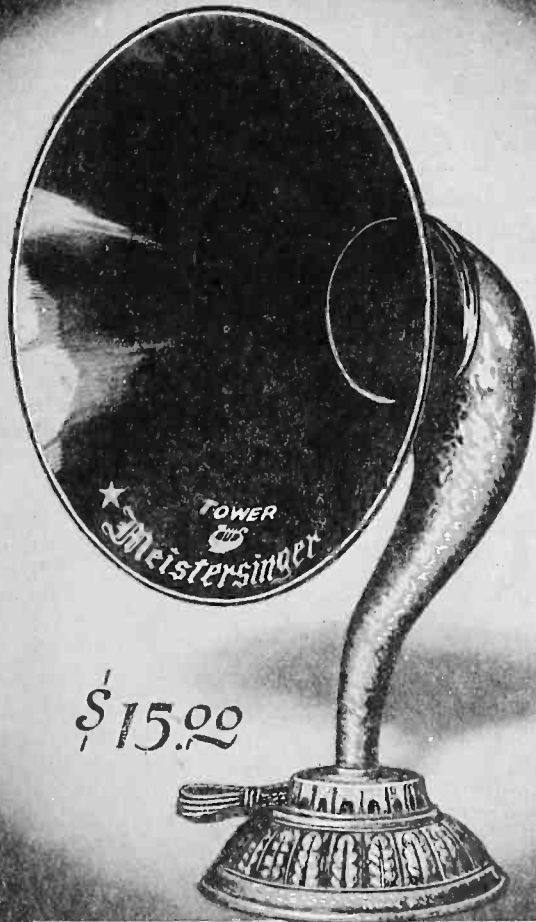

\$15.00

TOWER MFG. CORP.

BOSTON MASS.

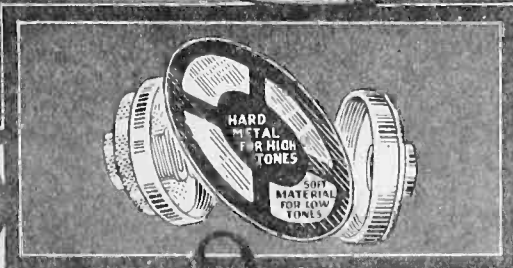

PATENTS PENDING



\$8.50 *Scientific*



Tower Scientific
\$2.95

These Tower Products equipped with this New Diaphragm

Phonograph Attachment
\$3.95

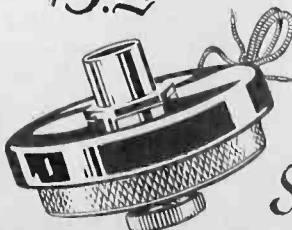

Little Spitfire \$4.95

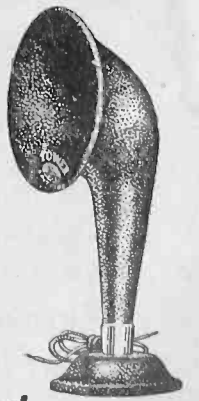

WORLD'S GREATEST SPEAKER VALUES

Tell them that you saw it in RADIO

RADIO

With Which is Incorporated "Radio Journal"
Established 1917

Published Monthly by the Pacific Radio Publishing Co.

ARTHUR H. HALLORAN

Editor

GERALD M. BEST
Technical Editor

H. W. DICKOW
Advertising Manager

Branch Offices:
New York City, 11 W. 42nd St.
Chicago, 307 N. Michigan Ave.
Boston, 57 Irving St.
Kansas City, Mo., Davies & Dil-
lon, 701 Land Bank Bldg.

Rates:
Issued Monthly, 25c a copy.
Subscription price \$2.50 per year
in the U. S., \$3.00 per year else-
where.

Correct Addresses:
Instructions for change of ad-
dress should be sent to the pub-
lisher 450 weeks before the date
they are to go into effect. Both
old and new addresses must al-
ways be given.

Advertising:
Advertising Form Close on the
First of the Month Preceding
Date of Issue.

Member Radio Magazine Publishers' Association
Entered as second-class matter at Post Office at San Francisco, Calif.
Copyright, 1926 by the Pacific Radio Publishing Co.

Address all communications to

Pacific Radio Publishing Company

Pacific Building, San Francisco, California

VOLUME VIII

APRIL, 1926

NUMBER 4

Forecast of Contributions for May Issue

Howard S. Pyle gives some interesting and useful hints on "Breaking Into the Radio Game."

Jennings B. Dow has a complete treatise on rectifiers, including electrolytic, thermionic, and mercury arc.

Raymond B. Thorpe writes with unusual clarity on the general subject of receiver selectivity wherein he presents data on the design of an electric wave filter to efficiently accomplish this purpose in a super-heterodyne.

John R. Loofbrouse recounts some important facts about dry batteries, their design, construction and use.

The transmitting amateur should be especially interested in A. Binneweg's article on the adjustment and operation of short wave oscillators, wherein he gives suggestions for securing maximum efficiency.

A half-wave A B C eliminator adaptable to any set using dry-battery tubes whose filaments are connected in series is illustrated and described by G. M. Best.

In "Getting Four Tubes Out of Three," L. W. Harry describes a reflex circuit without feedback through the audio transformer, thus improving tone and selectivity.

D. B. McGowan gives directions for constructing a 15-watt amateur transmitter employing several novel and useful ideas.

G. F. Lampkin presents helpful information on parallel operation of tubes in the Hartley circuit.

E. M. Sargent has two articles, one on "The Arithmetic of Radio" and the other on the construction of a four-tube receiver.

G. M. Best tells how to build an unusually simple and efficient short-wave receiver, using standard parts.

In "Something Hertz" Keith La Bar is author and Louis McManus is illustrator attractively present some historical facts.

The fiction feature is "Sweetheart, The Crazy" by Jan Dirk.

CONTENTS

	PAGE
FRONT COVER DESIGN	6
By W. H. Andrews	
RADIOTORIAL COMMENT	7
By Arthur H. Halloran	
ARMY AMATEUR RADIO NETS	8
By Robert Lighty	
BEST'S FIVE TUBE SUPERHETERODYNE	10
By G. M. Best	
RADIO TRANSMISSION OF PICTURES	15
By Dr. Milton Bergstein	
THE WONDERFUL BATTYOMETER	16
By C. Sterling Gleason	
THE RADIO SERVICE MAN'S BAG OF TRICKS	17
By E. E. Griffin	
ROLL YOUR OWN	19
By Frank J. Schindler	
SHORT WAVE REFLECTION PHENOMENA	21
By Everett W. Thatcher	
COIL DOPE	21
By G. F. Lampkin	
A BATTERY CHARGER RESISTANCE UNIT	25
By Harry R. Labcke	
A SINGLE CONTROL ALL-WAVE FOUR-TUBE RECEIVER	26
By McMurdo Silver	
THE EFFICIENT RECEPTION OF SHORT WAVES	29
By Willis L. Aye	
COMPARISON OF INDUCTANCE COILS	30
DESIGN OF LOW-PASS FILTERS	31
By Jennings B. Dow	
QUERIES AND REPLIES	35
RADIO STATION KFWI	34
By David Gibbons	
CRITICISM OF BRITISH BROADCASTING	34
INTRODUCING THE "COMMERCIAL BROADCASTER"	37
By P. S. Lucas	
NORTH PACIFIC SCHEDULES	37
By L. O. Duran	
GREAT LAKES REGS	38
By C. O. Sigfield	
"O" SIGNALS	38
By R. O. Koch	
CALLS HEARD	39
NEWS OF THE AMATEUR OPERATORS	39
FROM THE RADIO MANUFACTURERS	40



*“Your radio is always top notch.
What do you do to keep it so full
of pep?”*

KEEPING your “B” batteries full of pep, without frequent renewals, is simply a matter of using the right size Evereadys for your particular set with a “C” battery*.

The rule which determines the right size “B” batteries to use is so simple no one can make a mistake, and once learned it definitely settles the question of “B” battery service and economy.

On 1 to 3 tubes—Use Eveready No. 772.

On 4 or more tubes—Use the Heavy Duty “B” Batteries, either No. 770, or the even longer-lived Eveready Layerbilt No. 486.

On all but single tube sets—Use a “C” battery.

When following these rules, No. 772, on 1 to 3 tube sets, will last for a year or more, and Heavy Duties on sets of 4 or more tubes, for 8 months or longer.

These life figures are based on the established fact that the average year-round use of a set is 2 hours a day.

A pair of Eveready No. 772’s for a 5-tube set

instead of 2 Eveready No. 770’s or 2 Eveready Layerbilts No. 486—looks at first glance like an economy because of lower first cost. But in a few months the 722’s will be exhausted and have to be replaced. After the same length of time the Eveready No. 770’s or the Eveready Layerbilts No. 486 will still be good for many more months of service.

We have prepared for your individual use a new booklet, “Choosing and Using the Right Radio Batteries,” which we will be glad to send you upon request. This booklet also tells about the proper battery equipment for use with the new power tubes.

*NOTE: In addition to the increased life which an Eveready “C” Battery gives to your “B” batteries, it will add a quality of reception unobtainable without it.

Manufactured and guaranteed by
NATIONAL CARBON CO., INC.
New York San Francisco

Canadian National Carbon Co.,
Limited, Toronto, Ontario

LEFT—No. 486.
for 4, 5 or more
tubes. \$5.50.

RIGHT—Ever-
eady Dry Cell
Radio “A” Bat-
tery, 1½ volts.

EVEREADY
Radio Batteries
—they last longer

Tell them that you saw it in RADIO

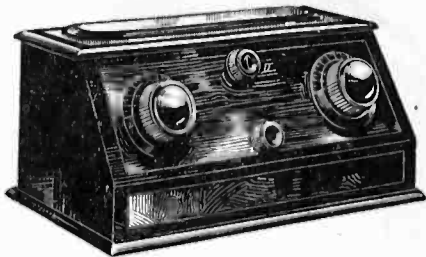

The Crosley 4-tube—4-29
in which the Crescendon is equal to one or more additional tubes of tuned radio frequency amplification . . . **\$29**



The Crescendon
—an amazing new volume control exclusive to Crosley sets. Hear it!

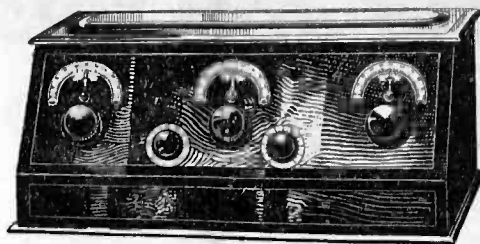

The Crosley 5-tube—5-38
All the volume, selectivity and purity of tone available in the best 5-tube set—plus the Crescendon . . . **\$38**

Widespread Popularity Marks Another Great Success

Spectacular as has been each stride in radio achieved by Powel Crosley, Jr., never before has a Crosley success received such prompt and widespread recognition. Here in the radio plant which has made more radios than any other factory in all the world, every man and machine is going at top speed, every hour is a crowded hour, every night a working day, as the result of orders for the four new Crosley sets.

Even the sweeping success of the Crosley Musicone did not match this merciless demand upon an organization tuned to mass production. With the first demonstrations by Crosley dealers, public approval was expressed in orders that have increased in volume day by day and show no inclination to relax.

This popularity is distributed quite evenly between the four new 4- and 5-tube sets. Thousands who had formerly believed that

worth while reception was exclusive to high priced sets, have found in Crosley 4-29 and 5-38 all that they could ask of radio. The accurate selectivity and pure tone of these instruments would be enough. That magnificent volume achieved through the *Crescendon* is the final touch.

And in Crosley "RFL" types there is a revelation for all. For here true cascade amplification makes its first appearance. Here what was considered *impossible* in expert opinion has been achieved by amplification closely approaching theoretical maximum efficiency per tube!

What a joy to find, and in a low priced set, rare beauty, rich tone, volume subject only to your desire, and no howling at any pitch by any mishandling under any conditions.

Each instrument delights the ear, fires the enthusiasm of the lay technician, converts the staunchest skeptic to love of radio.

See the new Crosley receiving sets at your dealer's or write Dept. 19 for descriptive catalog

Crosley manufactures radio receiving sets which are licensed under Armstrong U. S. Patent No. 1,113,149, or under patent applications of Radio Frequency Laboratories, Inc.

THE CROSLLEY RADIO CORPORATION, CINCINNATI, OHIO
 Powel Crosley, Jr., President

Owning and Operating WLW, first remote control super-power broadcasting station in America

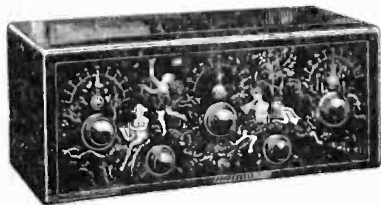

The Crosley 5-tube—RFL-60
A set of marvelous performance and beautified by the artistic decorative panel . . . **\$60**

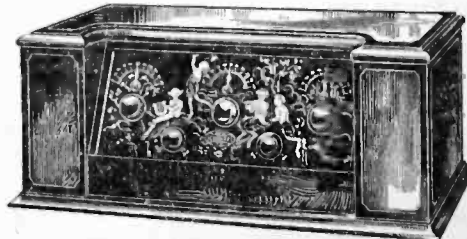

The Crosley 5-tube—RFL-75
Simplicity and speed in tuning, fidelity of tone and decorative beauty, enhanced by the art panel . . . **\$75**

Add 10% to all prices west of the Rockies

CROSLLEY RADIO

BETTER—COSTS LESS

FOR THE ENTERTAINMENT CORNER

Tell them that you saw it in RADIO

Send for this New Hookup

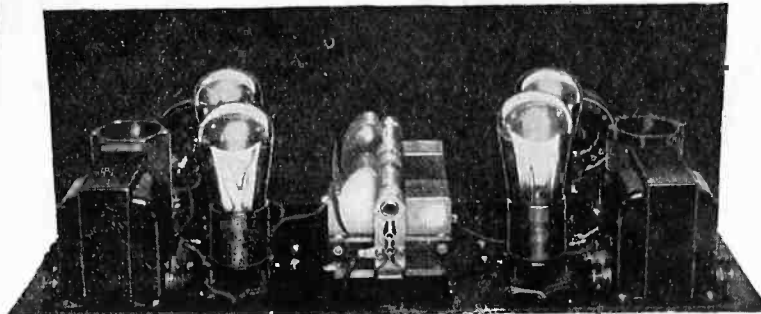

Four Tube Receiver

The outstanding radio receiver development of the season, in which is combined the genius of two of the most successful and distinguished radio engineers, assisted by the engineering and laboratory staffs of seven prominent radio manufacturers. The receiver for the home-builder that will represent for several seasons to come a far greater value than any other design available. Send for the book. Read how to obtain the following

Startling New Features

SINGLE CONTROL—But one tuning or station selector control.

SELECTIVITY—In a residential district of New York City, within a few hundred yards of powerful stations, thirty-five stations were heard between 9 and 10 p. m. on the loud-speaker. KFI, in Los Angeles, was heard with ample volume to fill two rooms. Tests in Chicago brought in either coast with ample speaker volume, and indicated that a consistent range of 1,000 to 2,500 miles might be expected.

QUALITY—Two new-type Thordarson power amplifying transformers possessing a substantially flat frequency characteristic over the range of 40 to 6,000 cycles, give a quality of reproduction so perfect that comparison by the best trained human ear with other types of amplifiers will not reveal any superior type.

VOLUME—In all cases the volume will exceed that obtainable from other four-tube receivers, and in practically all cases equal or exceed that obtainable from standard five and six-tube receivers.

UNLIMITED WAVE LENGTH RANGE—Through the use of interchangeable coils, the wave-length range is practically unlimited.

WIRING AND ASSEMBLY—All wiring is carried in a special harness. Since each wire is exactly the right length, and has a special color, it is impossible to go wrong in wiring. No soldering is needed unless preferred by the builder. Only a screwdriver and a pair of pliers necessary to assemble this set in less than two hours.

Over-all design, rugged and solid. Adapted to practically any standard cabinet, any standard tube, any battery or eliminator source of supply, outdoor antenna or loop. While the parts are the best that the leading laboratories of the country afford, the set can be built at an extremely low cost. Full description of the receiver was published in the March issue of Popular Radio.

Get the hand book at your nearest Radio Dealer or clip the coupon and send with 25 cents TODAY. Address



The S-C
Merchandising

Company
244 S. Wabash Avenue, Chicago

Gentlemen: Please find enclosed 25c, for which send me hand book of the new S-C Receiver.

No choicer group of radio products has ever been embodied in a single radio receiver. Not only are these manufacturers nationally known and accepted as the leaders in radio design and construction, but they have developed for the S-C receiver many new features which will create a new standard in reception throughout the radio world.

Represented Manufacturers:

Belden Mfg. Co.
S-C Wiring Harness

Central
Radio Laboratories
Centralab Resistance

Polymet Mfg. Corporation
Fixed Condensers, Leak
and Leak Clips

Poster & Co.
Drilled and Processed Front
Panel and Drilled Sub-Panel

Silver-Marshall, Inc.
Variable Condensers, Coil
Sockets, Coils, Tube Sockets,
Vernier Dial, Mounting
Brackets

Thordarson Electric
Mfg. Co.
R-200 Power Transformers

Yaxley Mfg. Co.
Rheostat, Jacks, Switch

The S-C Merchandising
Company
244 S. Wabash Ave.
Chicago

NAME _____

ADDRESS _____

Tell them that you saw it in RADIO

The Last word in audio amplification

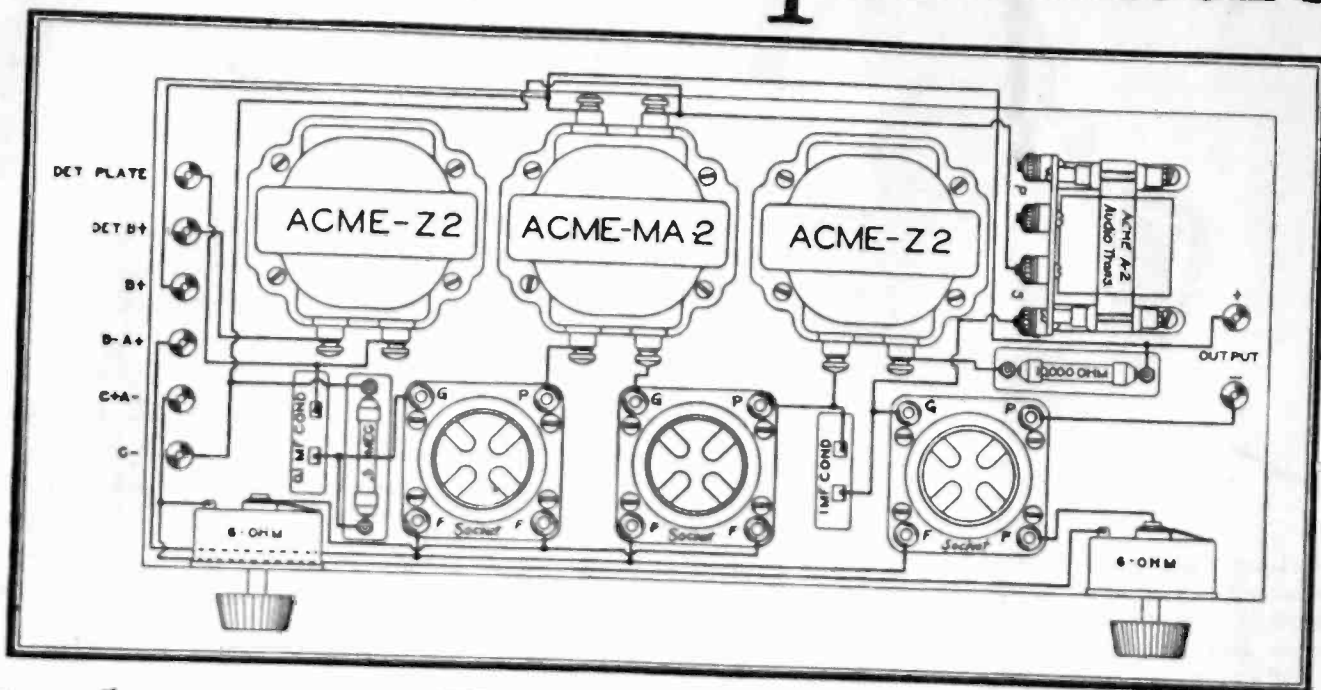

Impedance . . . Transformer . . . Impedance

THE diagram above will give you some idea of the very latest step in audio amplification. This is the outgrowth of nearly 7 years of experience in working on proper amplification—the problem of “How well you can hear.”

Whether you want to get a distant station or one right around the corner, the main thing is “How well you can hear.” Today’s broadcasting demands clear, understandable, full-noted music and voice. All the greatest artists are on the air; the greatest men talk to us. We don’t want to miss a note or word, nor do we want this music or these speeches distorted in any way.

You will probably remember the football game or the prize fight which was spoiled for you right in the most exciting part simply because you couldn’t understand the announcements or they were so muffled you had to strain to hear.

Acme research work has been confined to audio amplification and reproduction, and here you find the latest result. An audio amplifier using the combination

of impedance and transformer coupling with overall amplification greater than two transformers, and far superior in quality, no matter what the type of transformer used. Whatever set you have, just add this amplifier to your detector and notice the difference.

Send for Wiring Diagram

A complete working diagram of the above chart will be sent you for 25c in stamps or coin. It is easier to follow than the plainest road map. With this chart we shall be glad to send you free a copy of “Amplification Without Distortion,” a famous radio book over 300,000 radio fans have found helpful. It tells the whole story of distortion and how it can be overcome. In it also is complete information on the famous line of Acme products, including radio and audio transformers, amplifying impedance, the new Acme “double free-edge cone” loud speaker, the new Acme B-eliminator. Use coupon below for convenience. Acme Apparatus Company, pioneer radio and transformer engineers and manufacturers, Cambridge, Mass., U. S. A.



Illustration above shows the Acme M.A.2 Transformer, price \$5, and the Acme Z.2 amplifying impedance, price \$4. Both look alike, yet both serve a separate purpose. You need them both.

Amplification
without
Distortion

Partly Coast Factory Representatives:
THE SPECTOR COMPANY
Rialto Building, San Francisco

ACME

~for amplification

ACME APPARATUS COMPANY
Dept. D14, Cambridge, Mass.

Completion:—Enclosed find 25c (stamps) (coin), for which please send me full diagram as shown above and a copy of “Amplification Without Distortion.”

Name _____

Street _____

City _____

State _____

Tell them that you saw it in RADIO

RADIO

WITH WHICH IS INCORPORATED "RADIO JOURNAL"

VOLUME VIII

APRIL, 1926

No. 4

Radiatorial Comment

SINCE an educated public has learned to shun the junk parts, especially as high grade parts are now available everywhere, the get-rich-quick fakers have turned their talents to other branches of the radio art concerning which the public is not as well informed. The ignorance of fundamental radio principles is so widespread that thousands of people will buy any device that is advertised to prevent some of the well-known radio troubles. In luridness of announcement and in failure to perform many of these radio gadgets out-rival the old-time patent medicines that were advertised to cure everything from falling of the hair to ingrowing toe-nails.

The favorite bait is the static eliminator. Notwithstanding repeated statements that loud signals from strong stations are the best practical means for minimizing static interference every month seems to see new claimants to the honor and profit of having devised a static eliminator. So far as we are informed, none of them do away with this pest and the best of them merely give a higher ratio of signal to static intensity, which is already done by the bigger stations.

Anyone who studied the account of Dr. McCaa's patient scientific efforts as published in March RADIO realizes the truth of these statements. Various forms of rejector circuits can be made to reduce the proportion of static noise. Any form of high resistance in the antenna-ground lead will reduce the static but at a corresponding cost of reduction in signal strength. No magic panacea has yet met the general approval of radio engineers.

Another lure is the trick antenna that brings in distant stations better than the common garden variety of aerial. Compensated aerials, shoes that kick the signals into the set, and the ilk are advertised every day. The "inventor" of one of these, whose promoters became wrathful because legitimate radio magazines refused to accept their advertising, was recently arrested in New York for selling a "tubeless" receiver in whose base several tubes were skillfully concealed.

To impose upon the credulity of people is lamentably easy in radio. Recently a newspaper "fell" for a story of reception of Miami, Florida in the Yosemite Valley, California. The story was a hoax perpetuated by a group of practical jokers. But within a few days the store selling the particular set used reproduced the newspaper story in their advertising and undoubtedly sold many sets thereby.

This situation is gradually being cleared up by the radio trade associations and better business bureaus. It should also be the duty and privilege of well-informed radio men to expose such falsehoods. Many of them are innocently based upon ignorance, but their continuation after the fallacy has been explained is criminal. Therefore, let the industry rid itself of these human leeches.

WITH the probability of its being passed during the present session of Congress, the White radio bill becomes a matter of general interest. It will replace and repeal the obsolete law of 1912 under whose inadequate provisions radio has developed. It incorporates all of the important recommendations of the Fourth Radio Conference. Actually, it merely legalizes the control which has been exercised by the Secretary of Commerce in the past and thus places the industry on a much more stable business basis.

The greatest change in the old law, and the subject of much of the debate in committee hearings, was the proposed advisory commission of nine members representing the nine radio districts. This provision was incorporated at the direct request of Secretary Hoover who feels that some such agency is necessary to prevent any arbitrary exercise of power by the Department of Commerce. The decisions of both the Secretary and the Commission are subject to court appeal so that there is no chance for injustice.

This commission, in the final draft, is reduced to five members representing five zones of approximately the same population but of great disparity in area. The first zone embraces the northeast states, the second the central eastern, the third the southern, the fourth the north central, and the fifth all the states west of the Rockies as well as Alaska and Hawaii. For one man to be intimately familiar with all of the problems in the great area of the fifth zone, including the entire Pacific Ocean frontage of the country, will be a most difficult task.

While the general purpose of the bill is to impose full Federal authority over radio communication of all kinds, its regulatory action will probably first be felt by the broadcasting stations. The Department has already demonstrated that with the 89 wavelengths now available it is a physical impossibility to increase the number of stations without increasing the interference. As it is, with an average of six stations to a wavelength, widely apart geographically and limited as to power, the average listener finds difficulty in separating what he wants to hear. So at the Fourth Radio Conference there was a widespread demand for fewer stations, a change which the Commission may be obliged to recommend in the interest of better service. The commissioners may then become either the goats or the heroes, according to the point of view of the commentators. Other new points in the bill include the requirement that announcement be made when material is paid for or furnished by an advertiser, and also that there is no vested property right in a license or wavelength which the Secretary may revoke at his discretion and which cannot be transferred without his written consent. Station licenses are to be granted for a maximum period of five years in place of the present ninety-day limitation.

Army Amateur Radio Nets

By Robert Loghry

Radio Engineer, Signal Office, 9th Corps Area

REALIZING the great assistance rendered to the army during the World War by the radio amateurs, a conference was arranged last year between representatives of the War Department and representatives of the transmitting radio amateurs of the country with a view to organizing these amateurs into a vast radio network throughout the country to furnish communication for the National Guard and reserve components of the army of the United States in normal times and to fit these amateurs to efficiently serve their country in case of serious damage to the land line systems by flood, fire, tornado, earthquake, ice or other emergencies.

As a result of this conference a plan was drawn up and approved by the War Department and the representatives of the transmitting radio amateurs, and the American Radio Relay League was appointed by the chief signal officer of the army to act as the representative of the transmitting radio amateurs.

The plan provides the following:

(a) There will be organized in each Corps Area the following amateur radio nets, with amateur transmitting stations representing each military unit concerned:

1st—A Corps Area Radio Net, comprising the headquarters of each of its Organized Reserve Division, the Governor's Office in each state within its area, and a Corps Area Headquarters station acting as Net Control Station.

ARMY AMATEUR RADIO STATION



AFFILIATED WITH
THE SIGNAL CORPS
UNITED STATES
ARMY

This certifies that
Amateur Radio Station 6RI
Rt. 1247 47th Ave. San Francisco, California
owned by D. B. McGowan having been duly recommended by the representatives of the transmitting radio amateurs of the United States to serve as the Principal radio station of Headquarters Ninth Corps Area, is hereby designated an

ARMY AMATEUR RADIO STATION

As such, it is entitled to all the rights and privileges embodied in the Signal Corps plan of affiliation with the transmitting radio amateurs. The owners and operators thereof are empowered to transmit and receive such traffic of an official nature as may be necessary in the proper performance of their duties.

This appointment will continue in full force and effect for a period of two years unless sooner terminated for just cause.

Given under my hand and seal
this 15th day of Feb. 1926
At Presidio, San Francisco, Cal.

Arlowan

Colonel, Signal Corps, U.S. Army
Signal Officer, 9th Corps Area

First Certificate of Appointment as an "Army Amateur Radio Station" in the Ninth Corps Area.



2nd—A Division Radio Net for each of the Organized Reserve Divisions with Brigade, Regimental and such other nets as are necessary to properly provide radio communication for the units of the Organized Reserves.

3rd—A radio net for the National Guard of each state to be called the Governor's Radio Net and which will comprise all of the units of the National Guard of that state, grouped into Brigade, Regimental and such other radio nets as are necessary to properly provide radio communication for all of the units of the National Guard.

(b) The Corps Area Headquarters will be connected in an Army Amateur Radio Net with an Army Headquarters Station located at the Signal School, Fort Monmouth, Oceanport, N. J. The Corps Area Headquarters stations will be either privately owned and operated, or government-owned and operated so as to provide supervisory stations having direct contact with the amateurs within the Corps Areas and at the same time serving in the Army Amateur Radio Net. In either case the stations must be amateur stations working under amateur calls and complying with the Department of Commerce Regulations regarding amateur stations. The licenses for such stations must be obtained from the Radio Supervisor for the Radio District in which the Corps Area is located.

(c) To generate the desired amount of message traffic for the amateur operators to handle, it will be desirable for National Guard and Reserve Officers to transmit routine correspondence and reports by amateur radio, sending a confirmation copy by mail. The Corps Area Signal Officers and the Regular

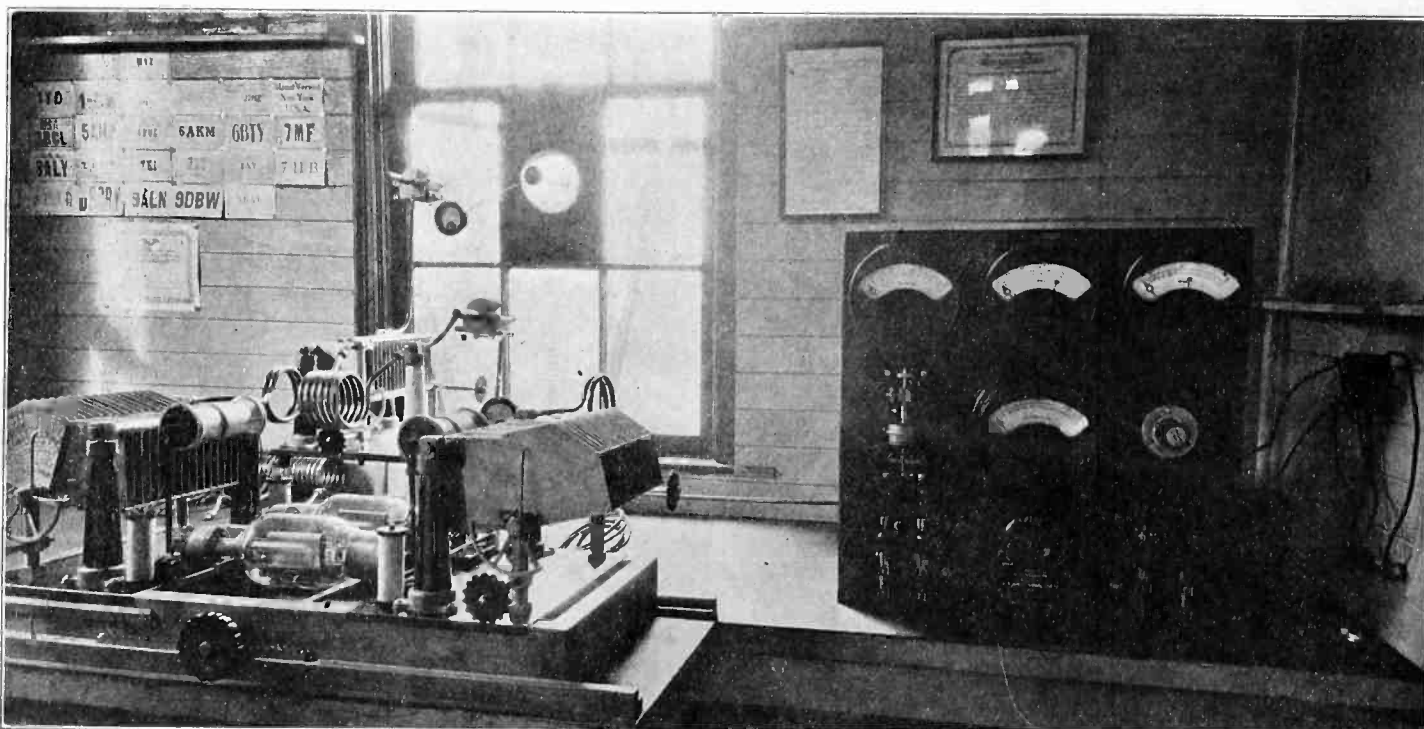

Signal Corps' 500-Watt Short-Wave Transmitter at Presidio at San Francisco; 500 Cycle Plate Supply with Tuned-Grid Tuned-Plate Circuit. Note Remote Control Relay on Left Side of Panel.

Army instructors should in turn transmit as much of their correspondence by amateur radio as possible and feasible, sending confirmation copies by mail. Traffic that would ordinarily go over commercial land lines will not be sent over amateur radio, but will be sent as formerly over commercial land lines. Amateur radio traffic should be considered as subject to a delay of from 24 to 48 hours. After the amateurs of a Corps Area have been trained for some length of time, this delay time will be cut down appreciably.

(d) In cases of local emergencies, where the land lines have ceased to function, any and all traffic should be sent by amateur radio. In such cases the local military units should be instructed to protect the radio station of the amateur serving them as this station may be their only means of communication with the outside world.

(e) Corps Area Signal Officers will arrange for periodic tests of the amateur nets under their jurisdiction. Some four to six tests per year will be run with messages starting at subordinate units and coming up through amateur radio channels to the Corps Area Headquarters. Similar tests of nation-wide character will be organized by the representative of the Chief Signal Officer at Fort Monmouth, Oceanport, N. J., and the representatives of the transmitting radio amateurs.

(f) On Defense Day each year every co-operating amateur should be at his station for the transmission of such messages as are filed with him.

A principal station and at least one alternate station will be designated for each unit where feasible. Where only one active amateur station is available, it may be designated to serve several units in the same locality. The designation of stations to serve such units to be made by the American Radio Relay League through their district representatives.

The amateurs designated to serve the various units either as principal or alternate stations should keep their stations open for the transmission of business on at least one night each week, preferably on the drill night of the unit or units they serve. The tender of their services is purely voluntary and they are at liberty to withdraw their co-operation at any time. No responsibility can be attached to them for any radio traffic that fails to reach its destination. They, as radio operators under the "Laws and Regulations Governing Radio Communication," are bound to preserve the secrecy of all radio messages. They are likewise duly obligated to comply with the above laws and such regulations as the Department of Commerce may promulgate and participation in this plan does not release them from this obligation. In time of local emergency

they will be expected to co-operate to the fullest possible extent with the local military organizations. In return, the local military authorities will do everything in their power to protect the amateur's station from injury.

The amateur is not expected to enlist or enroll in any manner. His main value to the working out of this plan is that of co-operating with the use of his own station in the transmission and reception of certain traffic of an official or semi-official nature. He will be expected to handle this traffic by the army methods of tactical radio procedure whenever possible. He will not handle this army traffic with stations that have not been properly designated as army amateur stations. He will be instructed in the use of certain codes and will in many cases be required to encode his messages before transmitting them. Likewise, he will have to decode such messages as come to him in code, before delivery to the local units. He will receive such instruction literature as is available from the Corps Area Signal Officer. When it is impossible for him to be at his station at the prearranged time, he will so notify the organization he serves so that the alternate station may be used at that time.

A certificate of appointment will be issued to each of the amateur radio stations accepting an appointment from their representatives to serve a unit of the National Guard or Organized Reserves. These certificates will be signed and sealed by the Corps Area Signal Officers, and are a confirmation of appointment and contain the authority for handling the official traffic of the units served. These certificates will be posted in a conspicuous place in the amateur's radio station.

Stations designated to serve in this plan will be known as "Army Amateur Radio Stations."

The Signal Corps cannot issue any equipment or apparatus to the amateurs for the operation of their stations.

The headquarters of the Ninth Corps Area, which comprises the state of California, Oregon, Washington, Utah, Montana, Wyoming, Idaho and Nevada, is located at the Presidio of San Francisco, California. Applications from radio amateurs residing in those states should be submitted to the Commanding General, Ninth Corps Area, Presidio of San Francisco, California, with the statement that the applicant is willing to accept an appointment as an "Army Ama-

(Continued on Page 60)

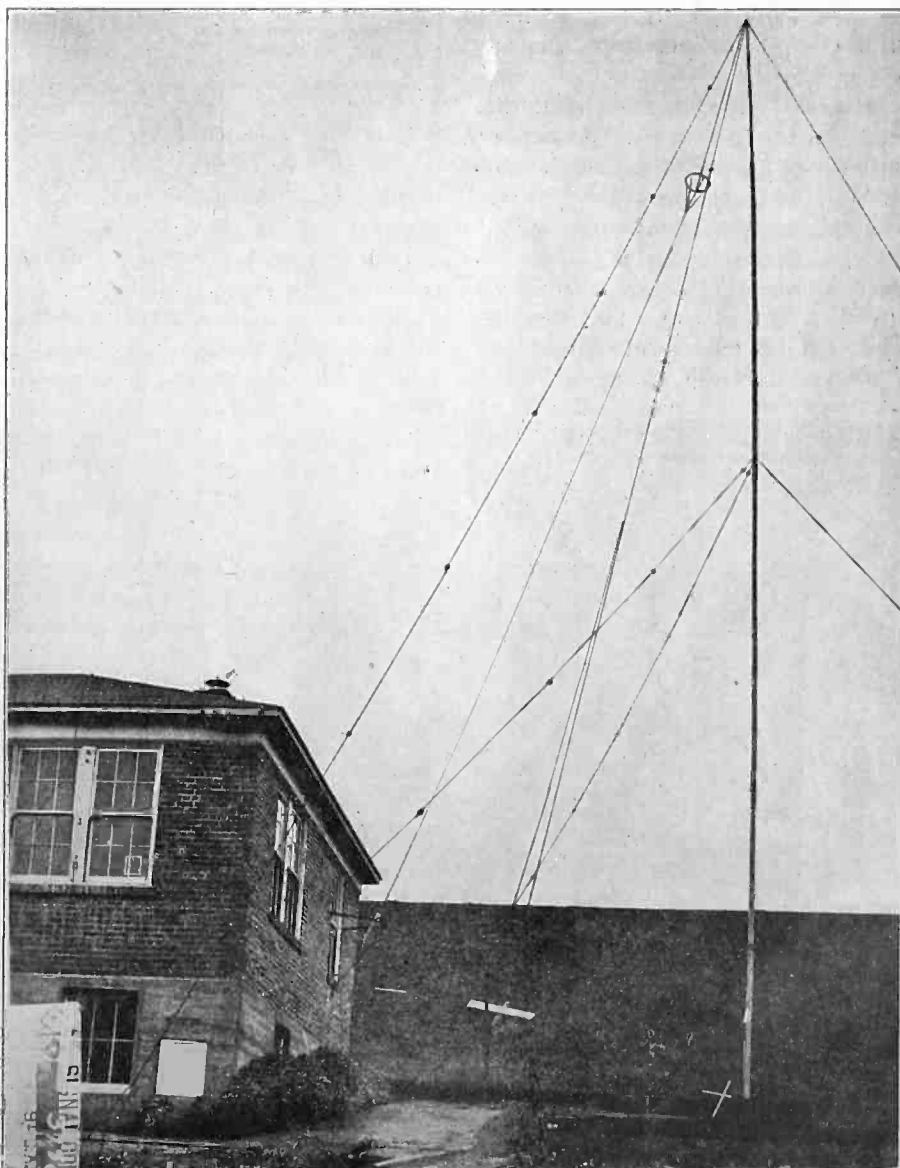

Sixty-Foot Mast Supporting 12,555 K. C. Antenna with Capacity Cage at Top.

Best's Five-Tube Superheterodyne

Adapted for Antenna Connection and Employing Large Tubes,---Oscillator,
Two I. F. and Two A. F. Amplifiers,---and Two Crystal Detectors

By G. M. Best

TO MEET the demand for an antenna-connected superheterodyne using storage battery tubes, a new version of the superheterodyne circuit has been developed in RADIO'S calibration laboratory. During development it was found that the choice of an intermediate frequency to give the best results depends upon the frequencies of the dominant stations in each locality, as is explained in the text. Circuit details are also given for the more conventional types so that the experienced constructor may thereby make whatever he prefers.

The salient features of the new circuit are: selectivity, even with the antenna connection; superb quality of output, due to the use of crystal detectors and high grade audio amplifiers; excellent volume with cone type loud speaker, by the use of a power tube; economy in battery consumption, as only five tubes are required, and ease of assembly, by the use of both sides of the shelf for mounting the apparatus.

The principal difference between this superheterodyne and others previously described is in the use of two carborundum crystal detectors for the frequency changer and detector, commonly called the first and second detectors. It has long been known that crystals could be used in these positions in a superheterodyne, but the objections were that the crystal was not easily adjusted, had a low internal resistance which destroyed selectivity, and was not sufficiently sensitive.

LIST OF PARTS

- 3 Variable condensers, .0005 mfd.
- 1 Antenna load coil—See text.
- 1 Antenna coupler—See text.
- 1 Oscillator coupler—See text.
- 2 Intermediate frequency transformers.
- 1 Filter transformer.
- 2 Audio frequency transformers.
- 2 Carborundum crystal detector units.
- 4 Automatic filament resistances—.25 amp. size.
- 1 Automatic filament resistance—.5 amp size.
- 1 Filament switch.
- 2 1 mfd. fixed condensers.
- 1 .006 mfd. mica condenser.
- 1 .002 mfd. mica condenser.
- 1 Filter tuning condenser—See text.
- 1 ½ megohm grid leak with mounting.
- 1 Tube protective resistance unit—500 ohms.
- 2 4½ volt C batteries.
- 5 X type vacuum tube sockets.
- 1 Single contact jack.
- 1 50,000 ohm variable resistor.
- 1 Binding post strip—7 posts.
- 1 Panel, 10x20x3/16 in.
- 1 Inkelite or Formica shelf, 5x18¾x¾ in.
- 2 Brackets for shelf—See text.
- Insulated and bare wire, 3 doz. ½ in.
- 6/32 r. h. brass machine screws and 4 1-in. flat head brass 6/32 machine screws for fastening brackets to panel.

unit is now available which consists of a small flashlight dry cell, a potentiometer, by-pass condenser and carborundum detector, arranged for convenient panel mounting and adjustment. The circuit of the detector unit is shown in Fig. 1, and indicates how the voltage adjustment across the crystal detector is obtained.

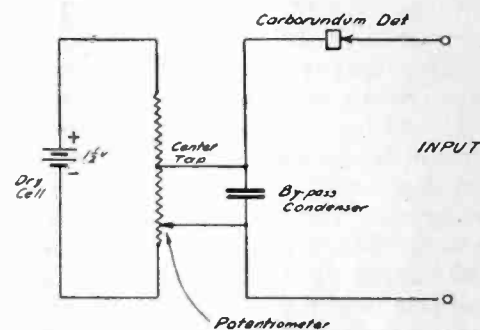
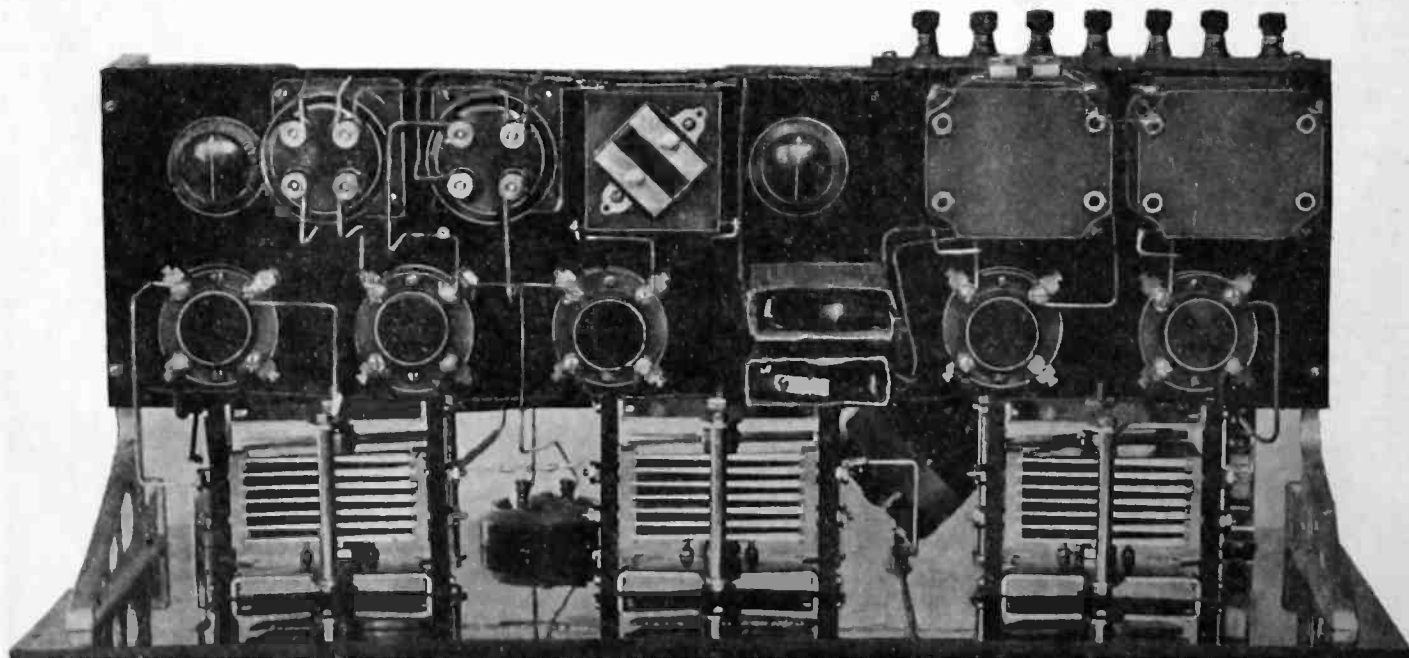

Fig. 1. Circuit of Carborundum Detector Unit.

Working with two of these detectors as a basis, a five-tube superheterodyne was developed, which has the sensitivity of a seven-tube circuit, with greater selectivity and less battery drain than conventional five-tube tuned r.f. receivers. By reference to the schematic wiring diagram in Fig. 2, the general arrangement of the circuit can be understood.

While the set can be operated with a loop antenna, many readers object to the loop for various reasons, and prefer to use an antenna. Realizing that the indiscriminate use of the set with the antenna without due regard to the radiation of the receiver when improperly op-

The new carborundum detector, however, has none of these disadvantages, as it has a permanent adjustment under pressure which prevents instability, has a high internal resistance, so that the detector will have little or no damping effect on the tuned transformer or antenna tuner, and is remarkably sensitive. The carborundum detector, in order to produce maximum results requires a small battery to control the detector resistance and sensitivity. A new



Top View, Indicating Position of Shelf With Respect to Panel.

erated, would cause a great amount of harm to neighboring receivers, an antenna system was selected, which, when properly adjusted, will cause a minimum amount of radiation of the oscillator output. The antenna circuit consists of series air condenser, loading coil, and coupling coil. If the load coil is the proper size, the antenna system will tune through the radiocast band without difficulty. The coupling coil is arranged so that very loose coupling can be obtained, and a center tapped secondary is used to obtain greater selectivity.

The antenna condenser is mounted on the left end of the panel, as is shown in the picture of the front panel layout, and the secondary tuning condenser, which is similar in size to the antenna condenser, is in the center of the panel.

The frequency changer circuit is connected to the secondary of the antenna tuner, and consists of a pickup coil placed in the field of the oscillator, a carborundum detector unit, and the primary of the first intermediate frequency transformer. The oscillator is of the conventional pattern, and is tuned by another variable condenser of .0005 mfd. capacity in series with a protective .006 mfd. fixed condenser, the latter preventing tube burnouts in case the air condenser develops a short circuit.

The intermediate frequency amplifier consists of two stages, with storage battery tubes. Details regarding the construction of the transformers will be given later in the text. The detector is another carborundum detector unit, placed between the tuned transformer and the first audio frequency transformer. In order to prevent undue damping of the tuned transformer by the crystal detector, the transformer should be of the tuned primary type, tuned by condenser C, the capacity of which depends upon the intermediate frequency desired. Data for this coil are given in a separate paragraph.

The audio frequency amplifier system is not new, but it consists of two high-grade transformers, which will amplify evenly and without distortion, all fre-

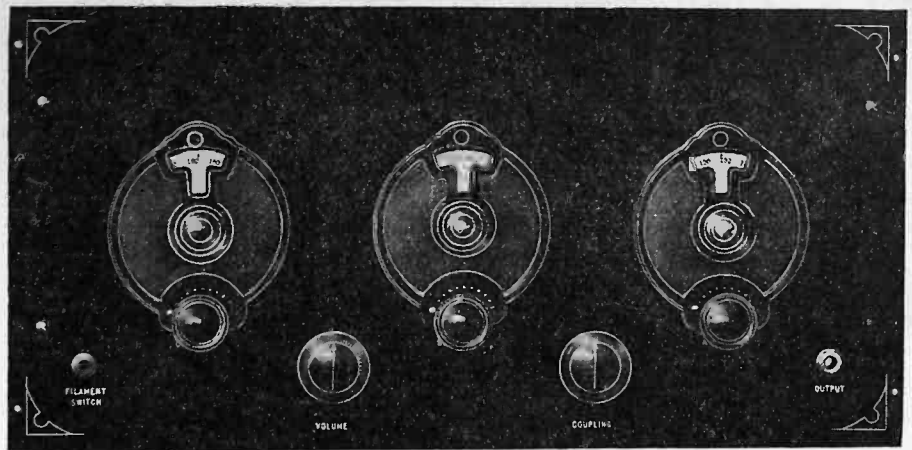

Front Panel View, Showing Three-Dial Control.

quencies from 50 to 5000 cycles. There are a number of different makes of transformers which fill these specifications, and the quality of the transformer used should depend upon the pocketbook of the constructor. In order to stabilize the circuit and prevent any possibility of oscillation troubles, the shields of the transformers are connected to the negative A battery and the secondary of the first transformer is shunted with a $\frac{1}{2}$ megohm grid leak. This is absolutely necessary if high-grade transformers are used, for if the shields are left floating, a continuous high frequency sing will occur, and will be impossible to overcome except by the above means.

The last audio stage is the power stage, and should be equipped with a type 112 power tube where a storage battery is used, or with a dry cell power tube if dry cell tubes are desired.

In order to simplify the operation of the set and reduce the number of panel instruments to a minimum, automatic filament resistances are employed, the only filament control being the filament switch. The volume control is made independent of the filament circuit, and should be either one of three variable resistances now available, the Royalty, Centralab, or Bremer Tully, all of 50,000 ohms maximum. If variable resistances of lower maximum are used, the set will be insensitive, and if the resistance is greater in value, the volume control will all be in the first half inch of

the potentiometer dial, and it will be difficult to control the volume on local stations. A 500,000 ohm potentiometer will not do, as it will be impossible to properly adjust it.

The list of apparatus given at the head of this article defines the parts to be used in constructing the set. With the exception of the Carborundum detectors, and the volume control there are a dozen good makes for each piece of apparatus, any one of which will give good results in the circuit, and so it is left to the buyer to judge which parts will be most suitable for his particular set, and to the dealer to recommend good parts which comply with the specifications. The panel template shown in Fig. 3 gives the center holes for each piece of panel apparatus. No mounting holes for the condensers, the vernier dials or the volume control rheostat are given, as templates are furnished by most parts manufacturers for their particular equipment, and would be more accurate than dimensions which could be shown in Fig. 3.

Most of the apparatus is mounted on a bakelite shelf supported by two aluminum brackets. If it is desired to make the brackets, a convenient bracket of 1/16 in. strip brass may be constructed as shown in Fig. 6. The air condensers used in this set must be 3 in. or less in depth, measured from the back of the panel. Otherwise the shelf will have to

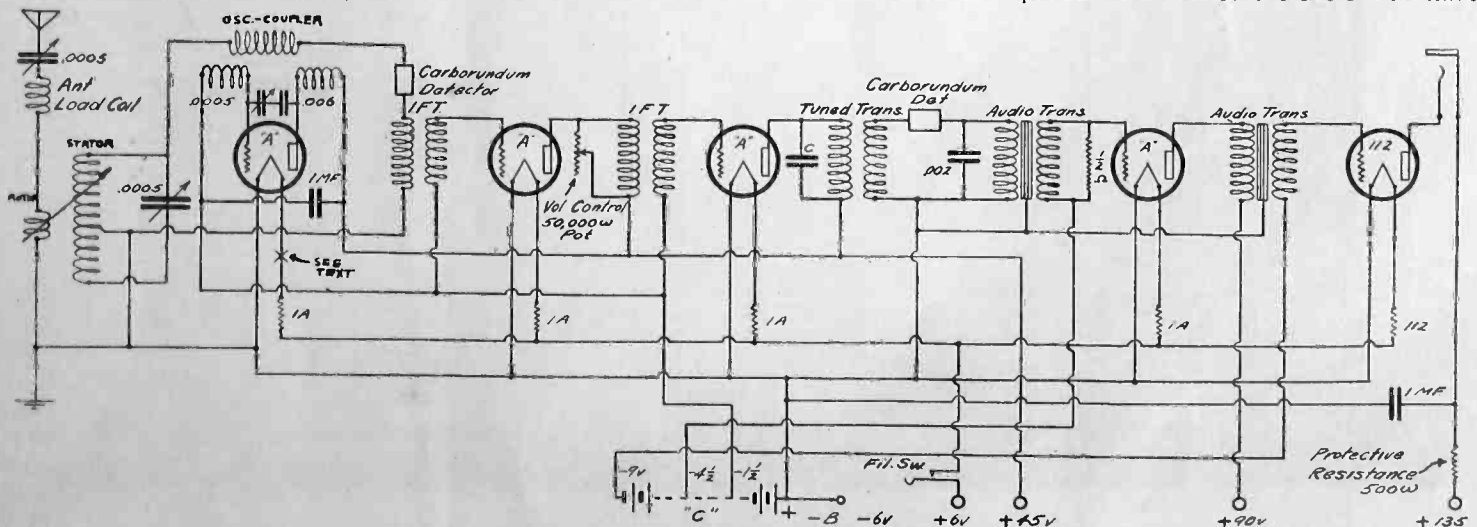

Fig. 2. Schematic Wiring Diagram of Five-Tube Superheterodyne.

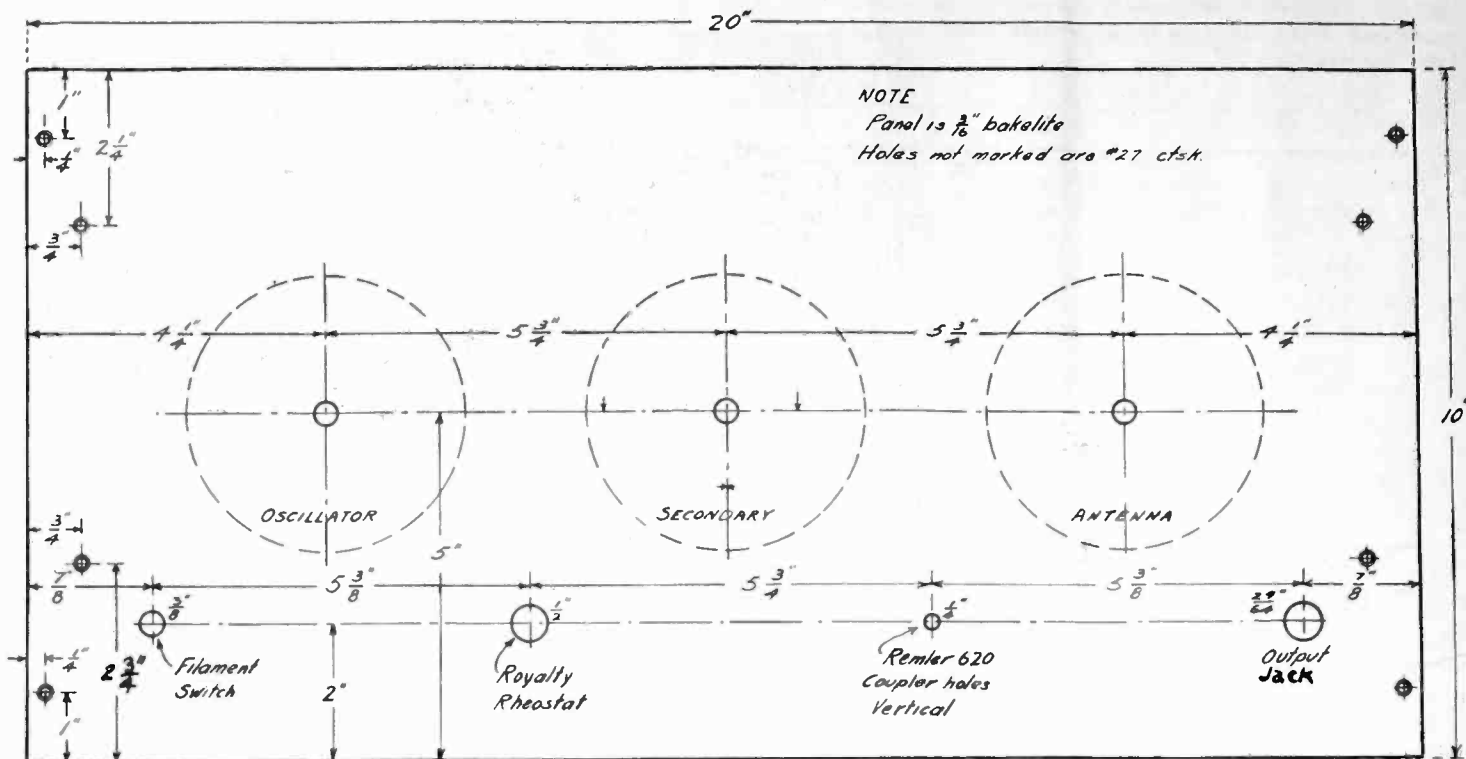

Fig. 3. Template for Drilling Panel.

be cut out to pass the condensers or made less than 5 in. wide. The bracket system of mounting was chosen in order that the baseboard might be level with the center of the panel, and so that equipment may be mounted on both sides of the shelf. This shelf is $5 \times 18\frac{3}{4} \times \frac{1}{4}$ in. of formica, and can be easily drilled with a No. 33 machine drill and tapped for $\frac{6}{32}$ machine screws, so that the apparatus can be securely fastened in place. It is placed $5\frac{1}{4}$ in. below the top of the panel and 3 in. to the rear of the panel.

Mounting screws are provided at each end of the shelf, and the brackets are fastened to the panel with four flat head $\frac{6}{32}$ machine screws. If the shelf is made of thin bakelite, the weight of the apparatus may in time bend the shelf, so at least $\frac{1}{4}$ in. stock should be used. Fig. 4 shows the shelf arrangement of parts, *a* being the top of the shelf, and *b* the bottom.

Looking down on the shelf, at the left is the frequency changer, which is a car-

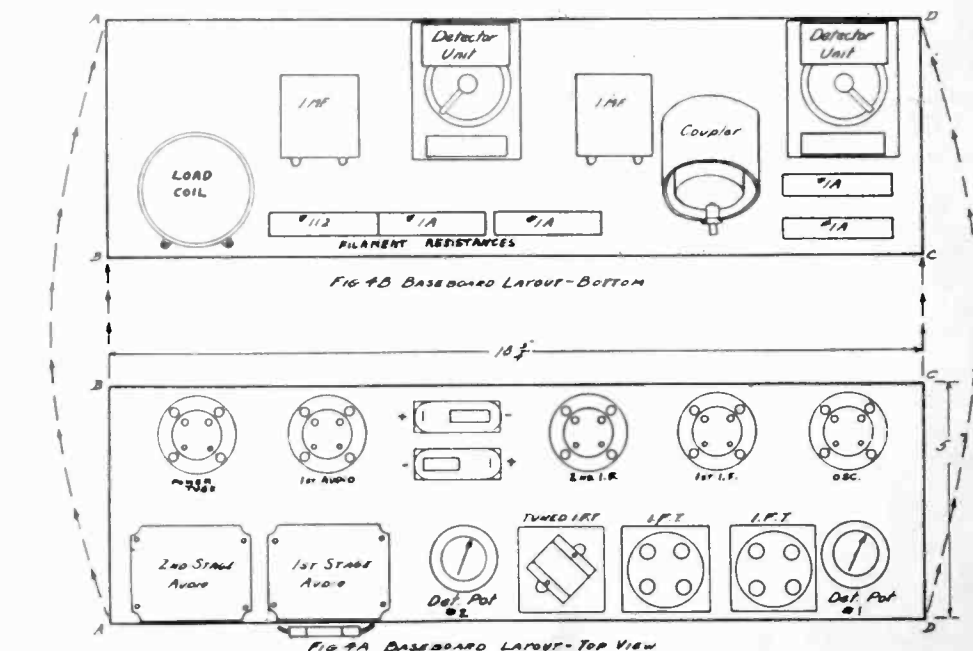

Fig. 4. (a) Top View of Shelf, Showing Actual Position of Apparatus; (b) Under Part of Shelf.

borundum stabilizing detector unit, mounted underneath the shelf, with the

potentiometer knob appearing on top. Next are the two intermediate frequency transformers, the filter transformer, the second carborundum detector unit, and the two audio transformers. The five sockets are, reading from the left, the oscillator, first and second intermediate amplifiers, and the first and second audio amplifiers.

The *C* batteries are mounted in the space in front of the second crystal detector, and should be of the small flat flashlight size, as the space is limited. The *C* battery consists of two $4\frac{1}{2}$ -volt sections, the $1\frac{1}{2}$ -volt tap being obtained by scraping away a small amount of the cardboard covering of the battery, next to the positive terminal, and soldering a wire to the zinc casing of the first dry cell.

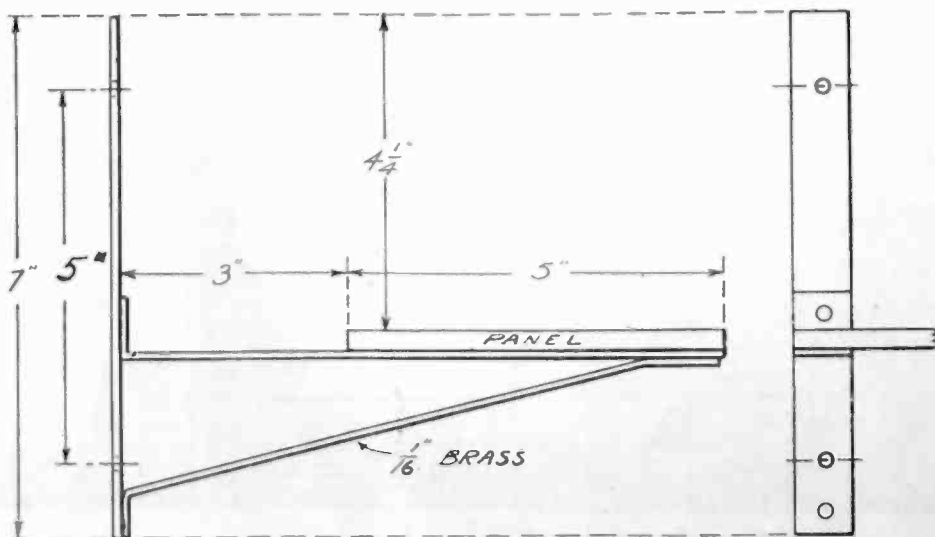

Fig. 6. Details of Brackets for Mounting Shelf to Panel.

NOTE: Position of apparatus correctly shown; one-half size for clearness in wiring. Dotted lines indicate under panel

135V 90V 45V -B
+B +B +B -A +A Gd. ANT.

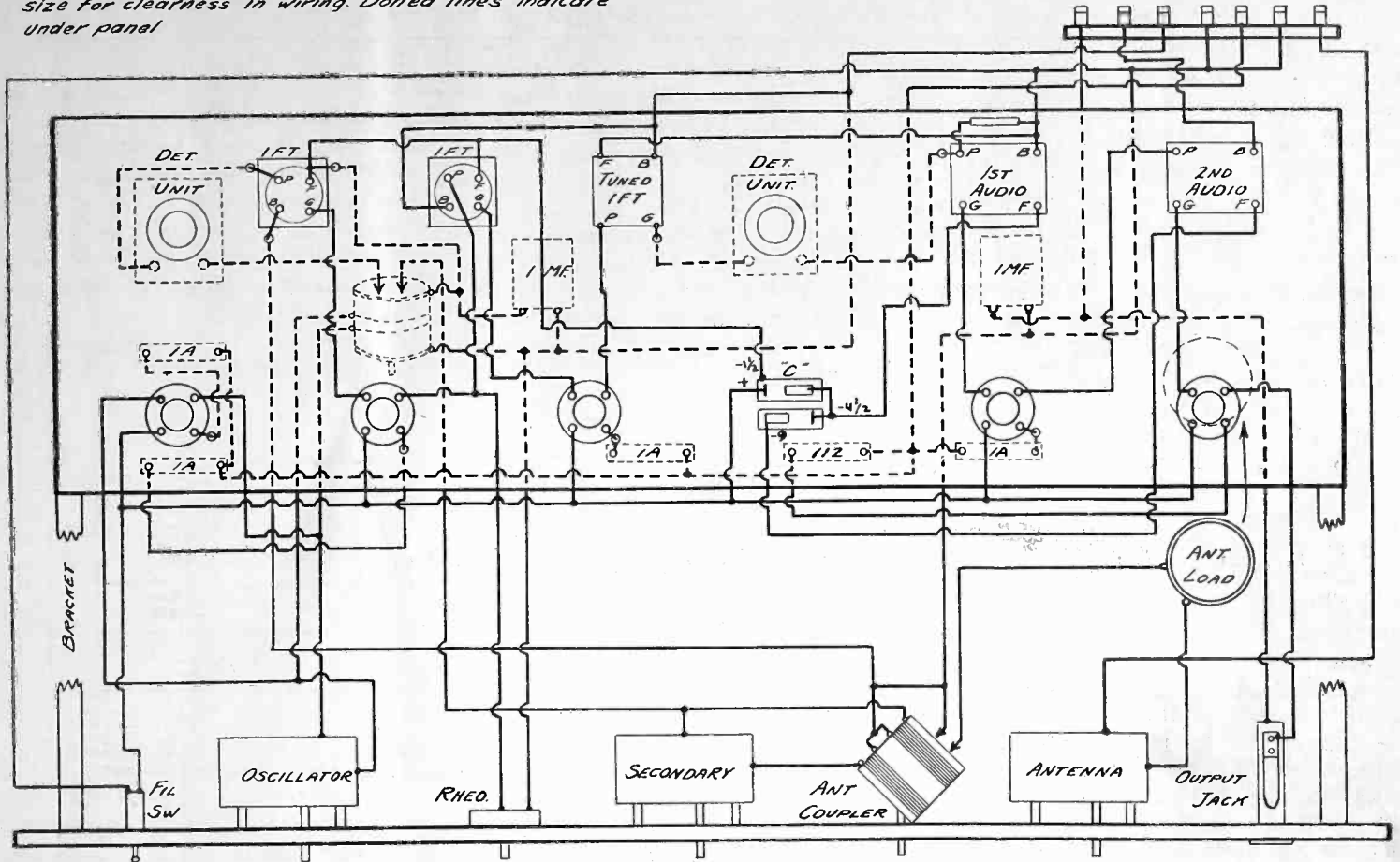

Fig. 5. Pictorial Wiring Diagram.

The tube protective resistance may be mounted close to the 135-volt *B* battery terminal on the back of the shelf. In case a bare wire inside the set should fall across the output jack, and the resistance was not installed, a disastrous short circuit might occur.

Underneath the shelf, at the left, are the oscillator coil, oscillator shunt 1 mfd. condenser, five automatic filament resistance cartridges, a 1 mfd. by-pass condenser in shunt across the 135-volt *B* battery, and the antenna load coil. The antenna coupling coil and secondary

tuned circuit are mounted on the panel, between the antenna and secondary condensers. Only one jack is provided, since this set is primarily designed for the loud speaker, but if additional jacks are desired, there is plenty of room on the panel for them.

The binding post strip is mounted at the back of the shelf, seven posts being required, (1) antenna, (2) ground, (3) negative *A* and *B* (connected to 2), (4) positive *A*, (5) 45-volt positive *B* (6) 90-volt positive *B* (7) 135-volt positive *B*. The cabinet should be provided

with a slot in the back, through which these posts will project, or else the cabinet should be made sufficiently deep to provide easy access in making the battery connections. As many experimenters like to construct as much of their own apparatus as is possible, the following data are given. All of it may be duplicated from apparatus on the market.

The antenna load coil may be made by winding 125 turns of No. 26 silk-covered wire on a $2\frac{3}{4}$ in. bakelite tube 3 in. long. The antenna tuning coil

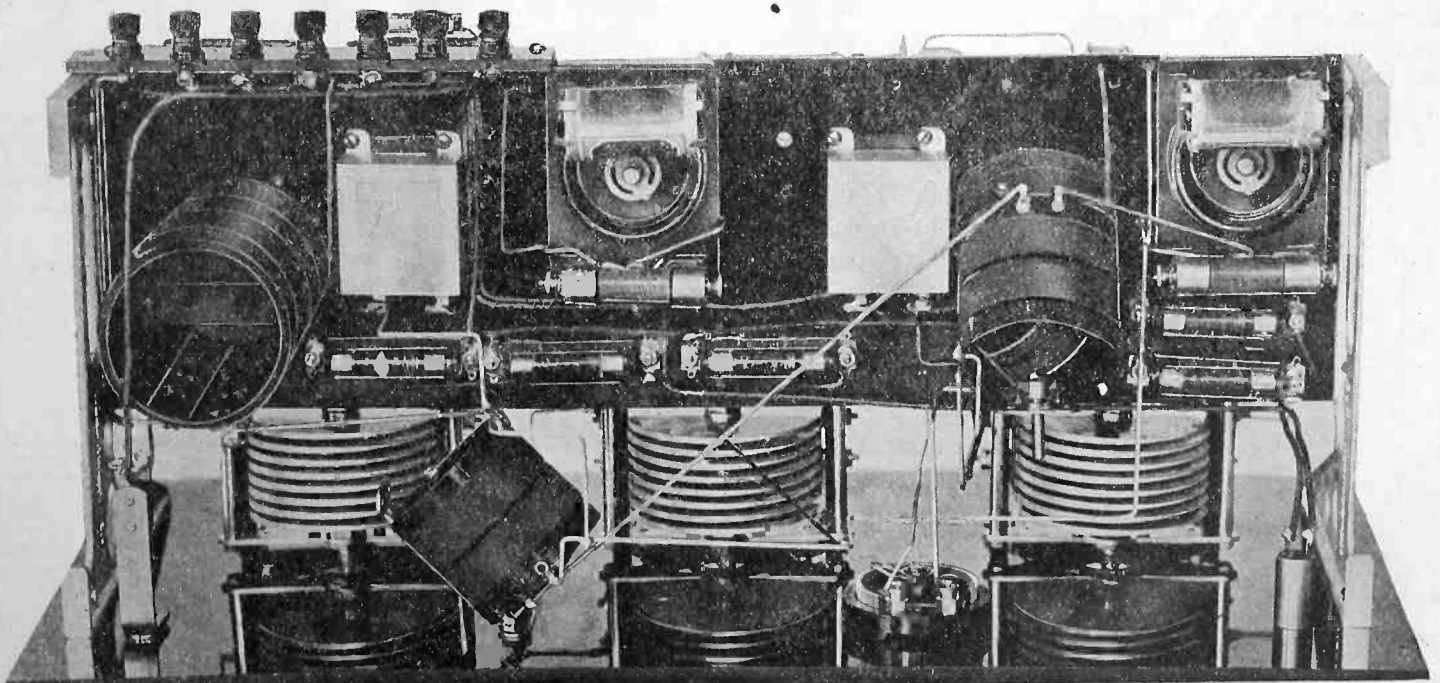

Bottom View of Shelf, With Wiring Details.

consists of a stator and rotor. The stator coil consists of 70 turns of No. 26 silk-covered wire, wound on a $2\frac{1}{4}$ in. tube, $2\frac{1}{2}$ in. long. A tap is taken off at the 35th turn, for connection to the ground circuit. The rotor or antenna coupling coil is wound on a $1\frac{1}{2}$ in. tube, and consists of 10 turns of No. 26 silk-covered wire. If the set is not sufficiently selective, it may be necessary to reduce the number of turns of wire in the rotor.

The oscillator-coupler is identical in dimensions, with the antenna coupling coil, except that when using the "A" tube as an oscillator, 5 turns in the pick-up coil will be ample, and it may be possible to reduce the turns to 3 or 4 where sufficient energy is obtained from the oscillator. In this connection, the "A" tube delivers more energy as an oscillator than a type 99 tube under similar conditions, and it is a good idea to reduce the oscillator output by placing an additional filament resistance cartridge in the position marked X on the schematic wiring diagram, Fig. 2, to reduce the filament current of the tube. A variable filament rheostat at this point would give greater flexibility, but it has been found that two 1-A Amperites in series will reduce the oscillator output to just the right amount. If the type 99 tube is used, the normal filament current of 60 milliamperes should be employed.

The construction of the intermediate frequency transformers is simple or difficult, depending upon the supply of core iron. It is out of the question for the average home set constructor, without calibration apparatus, to build air core intermediate transformers which will be tuned within 5% of each other, but iron core coils can be made to work satisfactorily with a reasonable amount of care, and the filter coil to go with the intermediates is not hard to build. Have two spools of the dimensions shown in Fig. 7-a turned out of hardwood or hard rubber, a $\frac{1}{2}$ in. hole being drilled through the center of the spool. In the center slot wind the primary, which consists of 500 turns of No. 32 single silk enameled wire, wound in a haphazard

fashion. In each of the two outside slots wind 1000 turns of No. 36 single silk wire, connecting the two secondaries in series aiding, the inside terminal of one coil being connected to the outside terminal of the other. The outside terminal of the primary goes to the plate of the intermediate amplifier tube, the inside primary to the positive B battery, and the outside terminal of the secondary coil whose inside terminal is connected to the opposite secondary coil is connected to the grid of the next i. f. tube, the remaining terminal being connected to the filament of the latter tube, through the C battery.

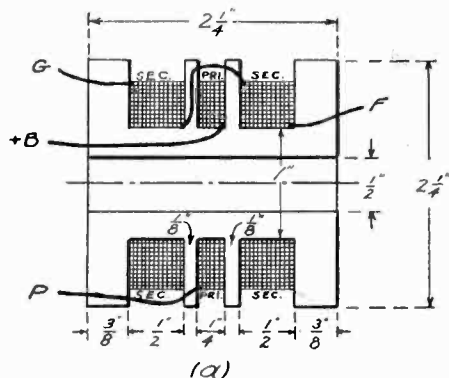

Fig. 7. Construction Details of Intermediate and Filter Transformers.

In the hole drilled through the center of the spool, crowd as much No. 36 soft iron or silicon steel wire as is possible, preferably bunching the wires together and wrapping with fine silk thread before placing in the spool, to insure solidity of the core. If very thin strips of silicon steel can be obtained, so much the better, the strips being crammed into the hole as tightly as possible.

The dimensions of the filter transformer are shown in Fig. 7-b. The primary is wound in the smaller slot, with No. 29 or 30 cotton covered, enameled wire, wound haphazard fashion. The secondary is wound with No. 36 single silk wire, the outside terminal being connected to the carborundum detector unit. The following table gives the number of turns and the value of the fixed condenser for the intermediate frequencies which are most desirable to use:

Frequency in Kilocycles	Primary Turns	Secondary Turns	Pri. Fixed Cond.
27	375	2100	.0075
32	375	2100	.006
37	333	1950	.006
42	295	1775	.006
47	250	1500	.006

It might be well at this point to clear up a question which has caused no little trouble among superheterodyne owners. The superheterodyne oscillator produces a beat frequency with the incoming signal frequency, the frequency of the beat note depending upon the frequency to which the filter transformer is tuned. Any particular intermediate frequency chosen for the filter will not be abso-

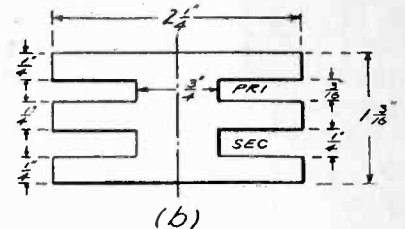

lutely satisfactory for all stations in any particular locality!

The reason is as follows: The oscillator is set a certain number of thousands of cycles above or below the incoming signal frequency, and the station can be heard at two points on the oscillator condenser dial. This is a familiar peculiarity of the superheterodyne. If the filter is tuned to say 45 kilocycles, the oscillator must be tuned to 45 kilocycles higher or lower than the signal frequency. When two locals, or one local and one powerful distant station are 90 kilocycles apart, and the oscillator is set half way between the two station frequencies, which would be 45 kilocycles in this case? Both stations would come in together, particularly if the volume control was advanced, and would hopelessly interfere with each other, producing a loud, continuous whistle. The

(Continued on Page 42)

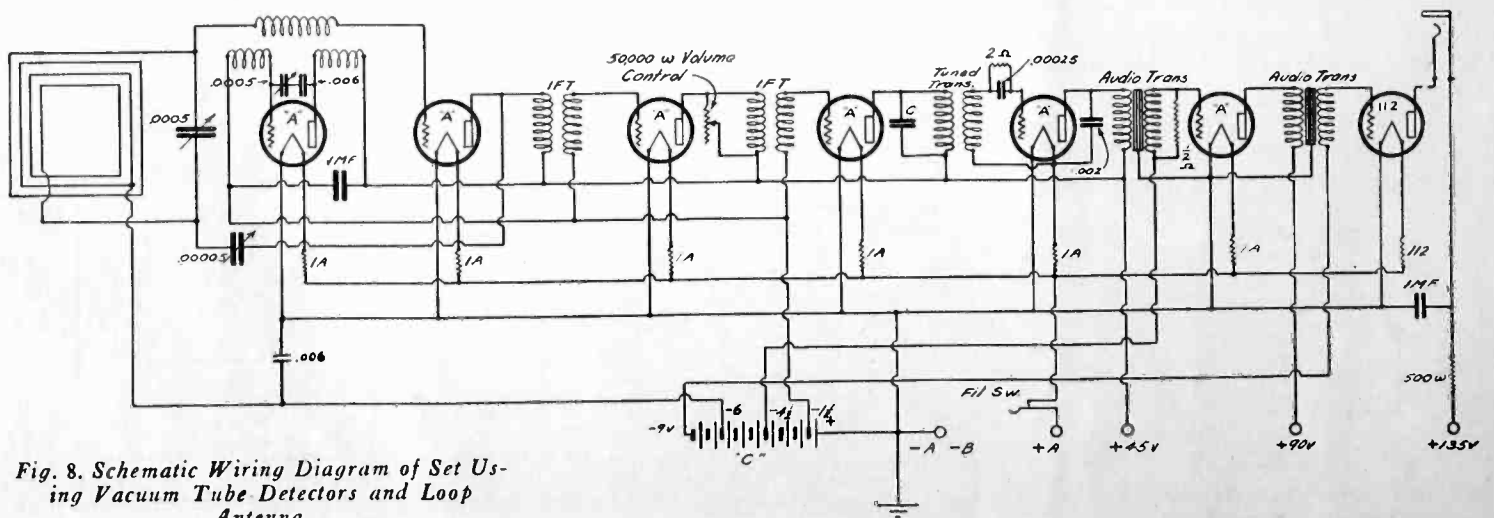

Fig. 8. Schematic Wiring Diagram of Set Using Vacuum Tube Detectors and Loop Antenna.

Radio Transmission of Pictures

An Interesting Account of Practical Investigations That May be Duplicated by Any Ingenious Experimenter

By Dr. Milton Bergstein

THE TRANSMISSION of pictures by radio is fundamentally a problem in synchronization. It is now readily possible, by means of a photo-electric cell to transmit and receive a carrier wave which is "modulated" by variations in light just as in radio telephony the carrier is modulated by variations in sound. But in order that the received variations may reproduce the transmitted variations as a distortionless photograph the mechanisms at the sending and receiving ends must be in exact step or synchronism.

If the sending and receiving instruments are situated so that both are fed from the same power system, using say 60 cycles a.c., they may often be kept in step so as to avoid distortion. If not, it is customary to operate them through frequency motors supplied with locally generated alternating current with control by a clock-work mechanism.

The necessity for synchronization is evident from a consideration of the usual method of experimental transmission and reception of pictures. The transmitter consists essentially of a motor-driven glass cylinder around which is wrapped the photographic film to be transmitted. An intense light is focused so as to pass through the film and fall upon a photo-electric cell whose electric current output is changed by variations in light intensity. This minute variation in current is amplified and used to modulate a carrier wave which is picked up by the receiving station. The cylinder revolves as a spiral so that each portion of the picture is allowed to impress its light or shadow characteristics upon the photo-electric cell. This procedure is reversed at the receiving end, the electric current variations controlling the amount of light thrown upon successive portions of a sensitive photographic film which is revolved at exactly the same speed as the film in the transmitter. How this may be experimentally accomplished will be explained after a brief discussion of

the photo-electric cell. The general principle is illustrated in Fig. 1.

This cell, obviously should be exceedingly responsive to variations in light, both as to sensitivity and rapidity of response, it should be constant in operation; stable in adjustment, and easily installed and operated. These several re-

quirements are well met by the phototron tube in which an alkali metal such as sodium or potassium, is deposited on the plate of a two-element tube containing one of the rare gases. The number of electrons freed from the alkali metal depends upon the intensity of light striking it. If a constant difference of potential be maintained between the plate, which is connected to the negative pole of a battery, and a collector or anode, which is connected to the positive pole of the same battery, the electronic emission from the alkali metal will cause a variation in the current flow. The output of the cell can then be amplified by a standard vacuum tube. The principle of this operation is illustrated in Fig. 2.

The amplified current is then super-

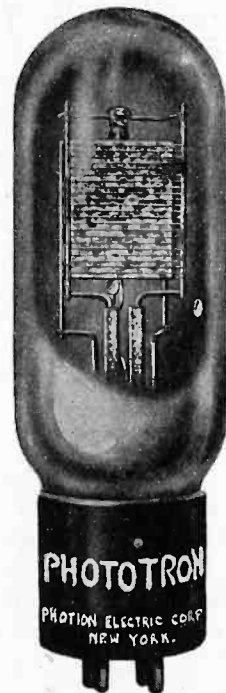

The Phototron Tube.

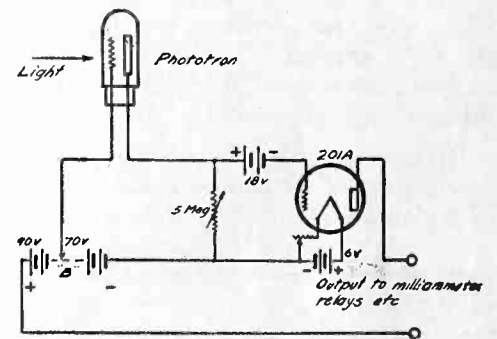

Fig. 2. Typical Set-up for Phototron With One Stage of Amplification.

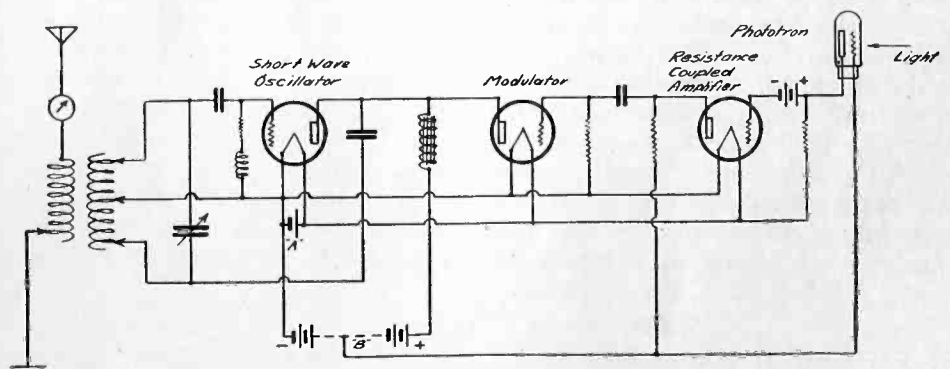

Fig. 3. Simple Form of Picture Transmitting Circuit.

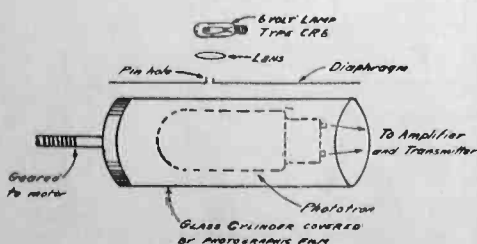

Fig. 1. Diagrammatic Sketch of Simple Picture-Sending Device.

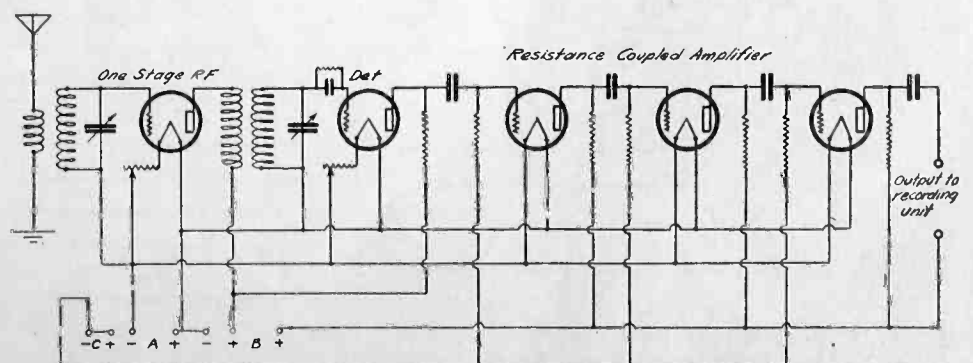

Fig. 4. Circuit Diagram for Picture Receiver.

imposed on a constant audio frequency oscillation which in turn is superimposed upon a radio frequency oscillation which is transmitted as a carrier wave. A simple form of the transmitting circuit diagram is shown in Fig. 3. The corresponding circuit for the receiver is shown in Fig. 4.

Various methods may be used to transform the received current into light intensities corresponding to those of the transmitter film. In Fig. 5 the recording unit consists of two fine wires sus-

whose diaphragm is mounted a mirror. This mirror receives the light from a lamp after it has passed through a grating and reflects it through another grating and lens onto the moving cylinder on which the record is made. In one position of the mirror the bars of light from the first grating fall on the transparent portions of the second, while in the position of maximum displacement they fall on the dark lines of the second grating and no light is transmitted to the cylinder. By proper adjustment of grat-

THE WONDERFUL BATTY-OMETER

By C. STERLING GLEASON

AND in the days of the fathers of the tribe of Ham, that dwelt beside the great waters, even the boundless Pacific, there lived a young Ham. And lo! as he readeth in the great radio periodical of his time, even "Wireless," there appeareth unto him an advertisement written in the language of his tribe, saying, 'LEARN THOU RADIO AT HOME. OUR WONDERFUL BATTYOMETER MAKETH THEE AN EXPERT OPERATOR IN SIX WEEKS. Thou shalt send no monies nor make recompense, but shalt use this coupon, hereto attached. Say thou unto the postman, "These ten dollars are thine; bring thou unto me this wonderful thing called the Battyometer, which teacheth the code in the space of six weeks. Do this that I have commanded thee, for I, likewise, would become a great radio operator, even a radio-electrician.'"

And it came to pass that in the fulness of time the postman doeth as he is commanded, and the Ham rejoiceth mightily. He taketh unto himself in the wilderness, even his own private sanctum, the Battyometer, and for six weeks showeth not his face, even at mealtime; and he groweth greatly in knowledge concerning the mysteries of radio, and especially wireless; he learneth regarding aerials, and crystals, and dynamotors, and decrement, and superfluous signals, and even impact transmitters; he readeth concerning this marvel called the audion, and learneth the use of a magnetic detector; he readeth of arcs, and learneth how to adjust quenched gaps; he readeth, and memorizeth, the fact that wavelength is equal to three hundreds of thousands of thousands divided by the frequency, and that the term "power factor" is used in a.c. work. And at last, finding himself of great knowledge and savoir-faire, he realizeth that he is indeed a radiotrician. For he hath attained such swiftness that he can indeed copy that which the Battyometer sendeth both backwards and forwards, and at the full measure of speed contained therein. And with the key can he even surpass the machine, so that his fist readeth like lightning. (Or thunder, saith some.)

And he cometh out of the wilderness into the bosom of his family. And the whole family marveleth greatly at his wisdom, and his mother swelleth with pride and saith, "Behold my son, in whom am I well pleased; for in knowledge he surpasseth even Marconi and De Forest; he sendeth the code as the Western Union; indeed, he is a great electrician, for doth he not fix the electric toaster, and repair the broken fuse plug? And he talketh learnedly with electricians, of cycles, and watts, and

(Continued on Page 24)

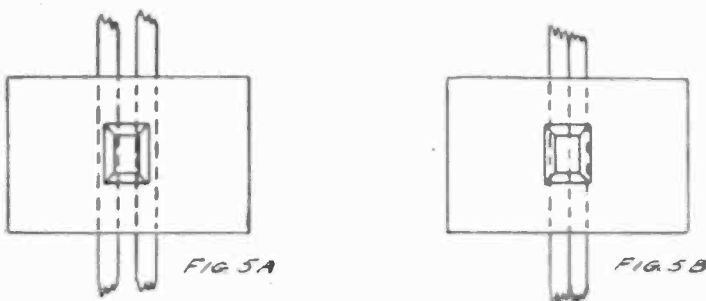
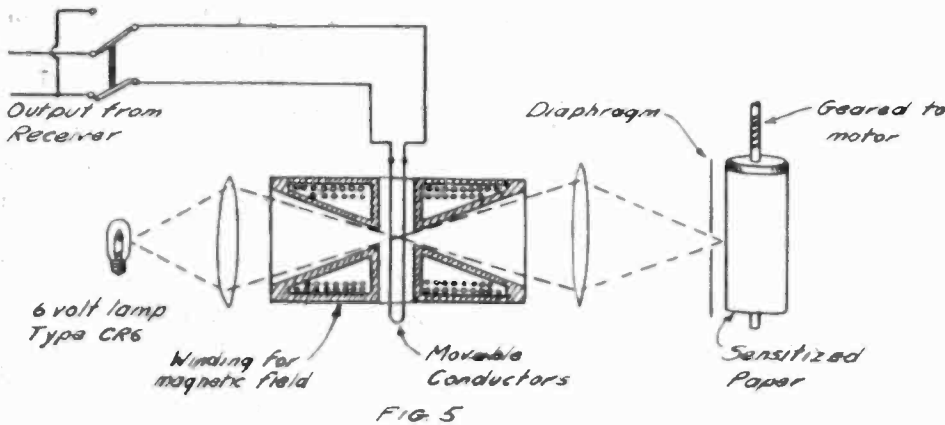

Fig. 5. One Type of Picture Recorder. (a) Shutter Opened to Maximum Width; (b) Shutter Closed.

ended in a magnetic field and placed between a lamp and the film upon which the light is recorded. These wires act as a shutter whose degree of opening depends upon the amount of current flowing through them. This shutter opens and closes at a frequency equal to that of the audio frequency current and the width of the opening is proportional to the intensity of the current as determined by the original intensity of the light controlling it. The purpose of the lenses and the rest of the equipment is self-evident.

In Fig. 6 the output from the receiver is passed through a telephone receiver on

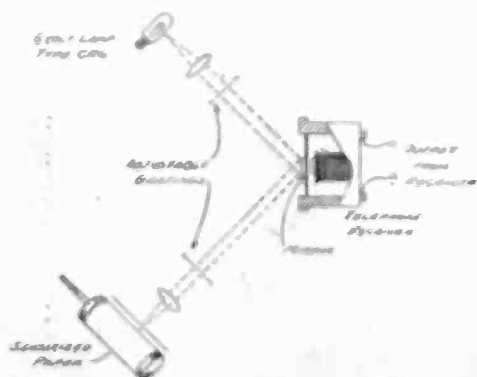

Fig. 6 Using a Telephone as a Picture Receiver.

ings, positive or negative may be obtained at will. As before, the sensitized paper or film may be removed and developed.

It is obvious that if a light of variable intensity be substituted for the mirror and grating arrangement, the receiving apparatus can be tremendously simplified. Such a light must vary in intensity almost instantaneously with the current input. The ordinary filament lamps, of course, are quite incapable of such behavior. Lamps of the gas ionic type vary almost instantaneously with electric current input but unfortunately only through a narrow range of light intensities and not over the complete range from dark to brilliant light. The manufacturers of the Phototron are now conducting experiments with a new type of gas ionic tube which it is hoped will be suitable for radio and telegraphic picture reception.

Although other methods, tending toward the transmission of moving pictures and television have been developed, these described are within the capabilities and limitations of equipment possessed by the average experimenter. This is indeed a fascinating field and will ultimately rival the reception of music in popular interest.

The Radio Service Man's Bag of Tricks

A Portable Service Kit That Has Stood The Test of Time in
Repair and Maintenance Work

By E. E. Griffin

THERE is an insistent and fast growing public demand for service: maintenance, repairing, overhaul and testing. In order to adequately meet this demand, the service dispenser must be equipped with tools and instruments of quite varied nature, which amounts to a machine shop and small laboratory combined. Complete overhaul, rebuilding or extensive alteration in a receiver must of course be performed in a shop. Diagnosis of ailments in receivers, however, is best performed at the location and under the conditions to which the set is normally subjected. Once the trouble is found, most cases show that permanent repair may be effected without dismantling and removal to the shop.

This article concerns the portable testing and repair set, one which has been formulated as requirements and necessity demanded being illustrated in Fig.

it may be accurately calibrated; and a buzzer added so as to give modulation of its output when used as transmitting oscillator. The circuit diagram is given in Fig. 3. A small single pole double throw switch is used to give two complete wavelength ranges on the single dial, and the regeneration is adjustable

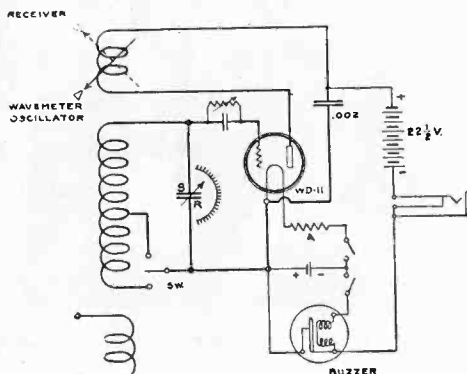

Fig. 3. Circuit Diagram of Wavemeter Oscillator.

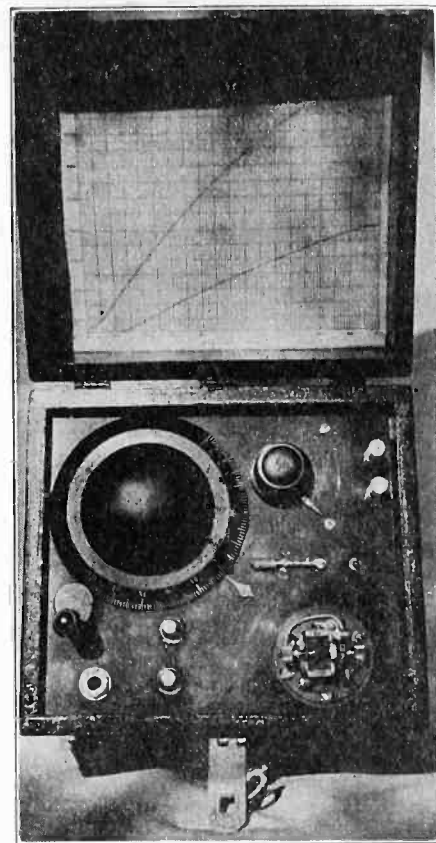

Fig. 2. Wavemeter-Oscillator.

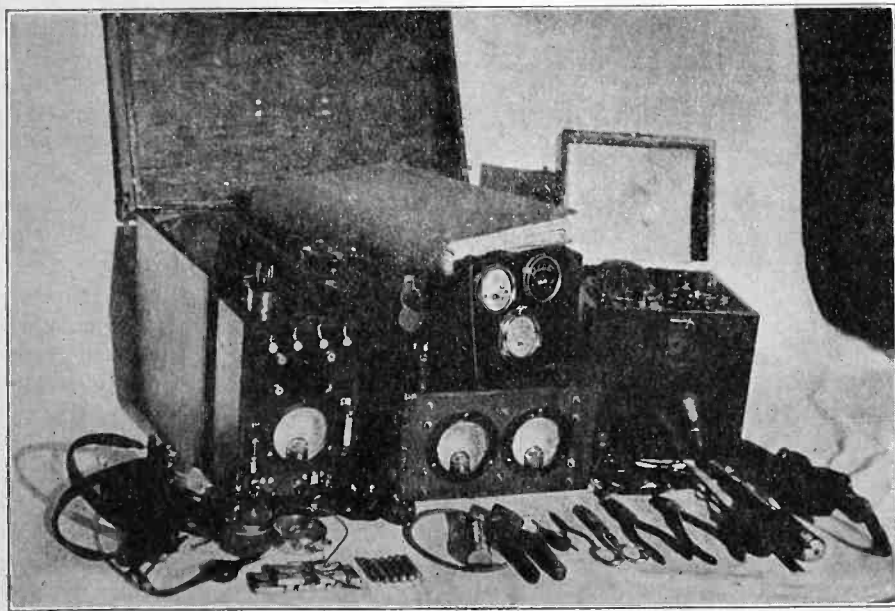

Fig. 1. Portable Testing and Repair Outfit.

1. It represents the result of over a year's use, having been revised from time to time as the need became apparent. The final result consists of a carrying case in which is included space for a wavemeter-oscillator tube tester, multi-range voltmeter and milliammeter, circuit tester, headphones, notebook, and small hand tools. Each of the larger articles performs multiple uses and each is considered indispensable.

The wavemeter-oscillator was fully described in October, 1925 RADIO. It consists essentially of a single tube regenerative receiver, so constructed that

so that it may be used as a single tube receiver. It is thus a receiver, oscillator, wavemeter and transmitter of modulated waves.

As a receiver, it is used to test antenna and ground installations. The fundamental of an antenna is determined by causing the instrument to oscillate and observing the click resonant point in its headphones. Loose connections and faulty circuits become audible. Likewise the tuning range of any receiver may be determined.

Used as a transmitter of modulated waves, any receiver may be pre-logged

or calibrated for all stations, since the wavemeter is adjustable to any station's wavelength. It is also used as a source of ICW when neutralizing or testing, thus eliminating the necessity of waiting for some station to come on the air. Accompanying it is a chart showing all stations listed by wavelength, with the proper wavemeter settings for each station.

The tube tester is illustrated in Fig 4, and the diagram of connections is given in Fig. 5. It consists of an 0 to 5 millimeter and a VT socket, with biasing battery arranged by switches and plug so that filament and plate current is supplied from a receiver. The plug is constructed from the base of a 199 type of tube, and from which lead the respective plate, filament and grid wires in the form of a four conductor flexible cord. One standard adaptor, when placed in the VT socket, arranges the instrument for testing 199 type tubes, and the same adaptor placed on the plug end arranges the instrument for testing the standard base tubes. For WD-11 type of tubes a special adaptor constructed by mounting a WD-11 socket on a standard base is necessary, and for plugging into CX sockets a 199

type of socket mounted on a CX base is necessary. One standard adaptor fits the CX tubes to the VT socket, and one standard adaptor fits the 199 plug to WD-11 sockets in a receiver using this

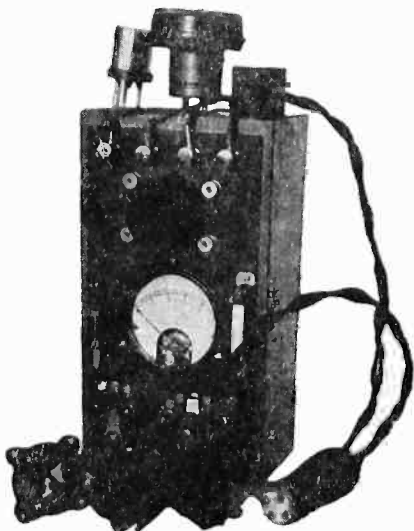

Fig. 4. Tube Tester.

type. Thus with the five attachments the tester is available for all present day receiving tubes.

A five point switch adds $4\frac{1}{2}$ volts positive or negative bias in addition to the set bias, the middle position being the set bias only. A three-point switch is arranged so that tubes may be tested independently of the set bias, necessary

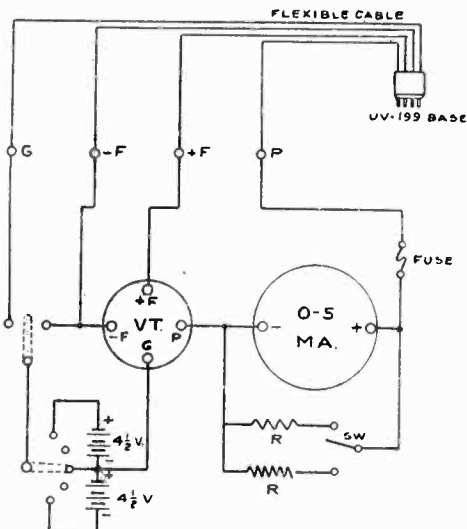

Fig. 5. Circuit Diagram of Tube Tester.

of course in the case of a single tube receiver consisting of detector only. In this case the grid return from the tube is connected to the negative filament. The middle point of this switch and the second and fourth taps of the five-point switch are open so that the switch lever does not cause a short. The milliammeter is arranged with a protective fuse and two shunts, giving ranges of 0-5, 0-10 and 0-50 mills. In case of the new power tubes it is necessary to test from their special socket, since they require higher bias. The tester then adds or lessens the normal bias by $4\frac{1}{2}$ volts. Thus in the case of the CX-120 our grid voltages would be 18 minimum and 27

maximum, considering $22\frac{1}{2}$ volts normal bias.

In addition to tube testing, this instrument is also valuable for circuit testing. Open filament is evidenced in the tubes not lighting, open plate by the tubes lighting but no plate indication, open grid by steady reading of the milliammeter regardless of the position of the biasing switch. Improper values of *B* and bias voltage are also made evident by the "modulating up" or "modulating down" movements of the milliammeter.

The voltmeter-milliammeter combination is illustrated in Fig. 6 and the diagram given in Fig. 7. It is composed of two Model 301 Weston instruments: 0-8 voltmeter and 0-300 milliammeter. The voltmeter is supplied with additional multiplier resistances, giving ranges of 0-2, 0-8, 0-80 and 0-200, with

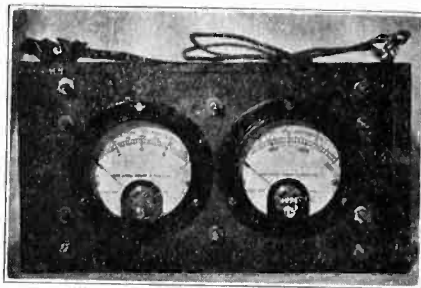

Fig. 6. Voltmeter-Milliammeter Combination.

the scale captioned accordingly. The shunt of the milliammeter has been removed and supplied with four additional

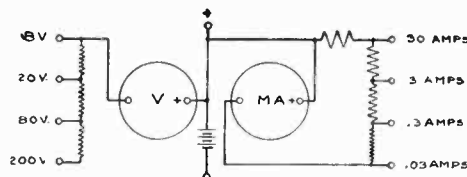

Fig. 7. Circuit Diagram of Voltmeter-Milliammeter Combination.

shunts, giving full scale readings of .03, .3, 3, and 30 amperes.

Thus the instrument is equipped for measuring any voltage in common use and any amperage from the short circuit current of a dry cell down to the total *B* drain of a receiver. The 0-5 milliammeter on the tube tester is available for lower ranges by connecting the voltmeter's flexible leads to the plate terminal and the fuse block of the tube tester. In this meter combination is also included a small $4\frac{1}{2}$ volt battery which is useful in connection with either instrument, as in testing for circuit continuity, shorts, etc.; also for a current source when measuring resistance by the voltmeter ammeter method. The center post of the instrument is positive and common to both meters and battery, the various ranges being obtained by shifting the negative lead on the outer posts. Shifting the positive lead from the upper post to the lower puts the battery in circuit.

The circuit tester as illustrated in Fig. 8 is primarily a time saver. It consists

of three small voltmeters of the cheaper grades, one 0-50, one 0-6 and one of 0-10 volts or higher. They are connected in series as shown in Fig. 9 and supplied with a flexible cord and 199

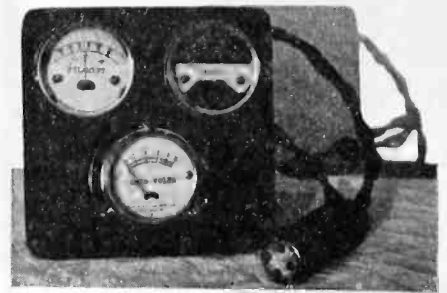

Fig. 8. Circuit Tester.

plug similar to the tube tester. The adaptors used with the tube tester are also used with this instrument.

The filament voltmeter is of the usual permanent magnet type with an improvised scale of double reading, the pointer

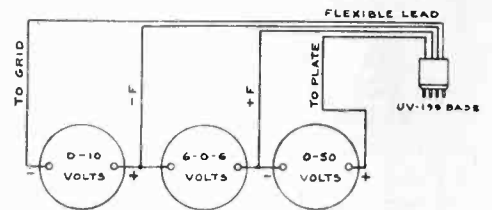

Fig. 9. Circuit Tester Diagram.

hand being bent so that its zero position is in center scale, indications of $1\frac{1}{2}$, $4\frac{1}{2}$ and 6 volts being marked on either side of zero. The grid voltmeter must be fairly sensitive, since its actuating current on audio frequency sockets is limited by the resistance of a transformer secondary or a resistor in the average set. The one illustrated is wound to 1000 ohms and requires 10 milliamperes for full scale deflection.

In the wiring of this instrument it has been assumed that the average receiver has its *C*, *A* and *B* batteries connected in series. In many factory sets, however, detector and oscillator tubes filaments are the reverse of amplifier filaments, thus the necessity of a differential indicating instrument for filament in our tester.

In use, this combination proves invaluable in many ways. It instantly shows circuit continuity, method of battery connection, and serves as a safeguard before inserting tubes in a set. In receivers having no bias battery, reversal of the filament battery leads to the set suffice to give indication on the grid voltmeter as to grid circuit continuity. The actual values of voltage as indicated by the instruments are of course in error, since there is additional resistance in series with both the plate voltmeter and grid voltmeter, and the filament meter will register total battery voltage. Except on the filament voltmeter, values are disregarded,—all that is required is current indication of the

(Continued on Page 50)

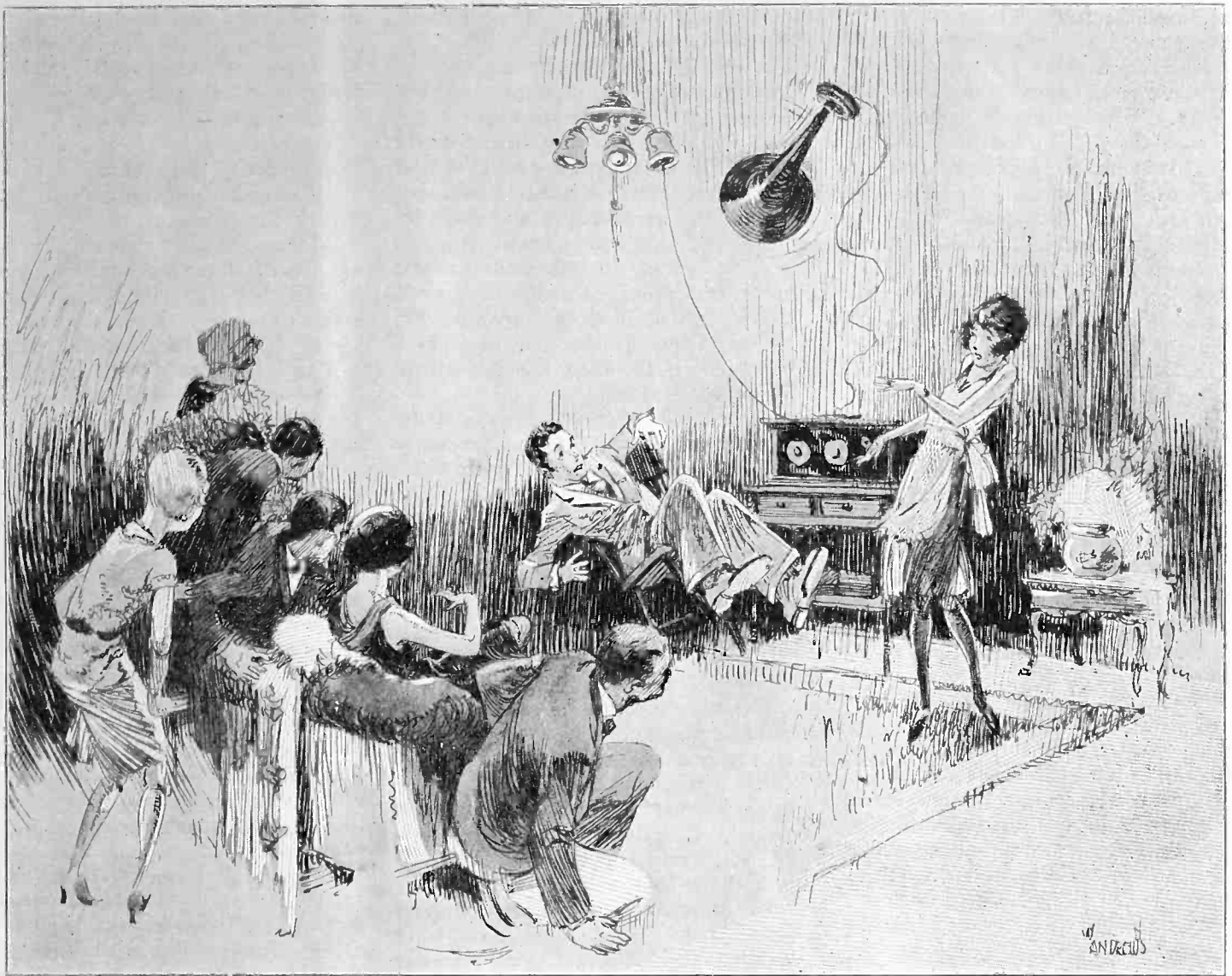

"It hit the ceiling and crashed to the floor."

Roll Your Own

By Frank J. Schindler

OVER in Berwyn, which is a suburb of Chicago, was John's electrical shop. And in Oak Park, that biggest of villages with Sundayless movies, lived Sobby. Sobby played a sobbing calabash—B flat tenor saxophone—and was a modern exponent of jazz breaks and four in a bar jazz counterpoint. You may not know what that is, but it doesn't matter—much. The only thing intricate about it is, that, no matter if the orchestra is playing "Yearning" or "No Wonder," this four in a bar jazz counterpoint sounds all alike, and that regardless of the key the "chune" is played in.

Sobby was a wise guy. As a radio variometer engineer, he was the best sobbing calabash sobber in the orchestra he sobbed with, or with which he sobbed, if you're fussy about prepositions.

Being in a state of coma one day, after a hard night of playing jazz breaks and four in a bar jazz counterpoint, Sobby, in some way or other, wandered

into Berwyn, which is something no good Oak Parker will do, unless he has been chloroformed or under the influence of paint shop hootch.

Sobby, in his wanderings, happened to pass John's electrical shop. "Ask John, he doesn't know either," read the slogan on the window card. Peering through the door, into the shop, he saw John talking to a radio salesman, who was hooking wires to a long radio receiver with a 48 in. panel. Through a haze of jazz breaks and four in a bar jazz counterpoint, it struck Sobby that he and John were old friends. He pushed the door open and walked in.

"Hello, Sobby," said John. "Stick around, you'll hear some music."

Of course, that tickled Sobby. Music was all he wanted to hear nothing else less. After sobbing jazz breaks from eight in the evening until two in the morning, he was due to get a thrill. Inquisitively he stood around and watched the salesman hook up all those

mysterious wires. A garage hand drifted in, bought a yard of wire, drifted out, drifted back in with a car washer, chauffeur and a janitor. The janitor drifted out and came back with a movie operator, one movie organist, one lady ticket seller and a piano tuner. The car washer drifted out and came back with a battery expert, a brick layer, one El conductor off duty, a motorcycle cop and a ham sandwich and a bottle of root beer. Meanwhile, while the salesman fumbled around with more wires, the piano tuner, movie organist and the ticket seller drifted out and drifted in with males and females of all vocations.

"All set," said the salesman, rubbing his hands. "This is some set! One stage of untuned radio frequency, two stages of tuned radio frequency and three stages of audio. Three variometers and two condensers tune this set, folks—that's all. It's simple."

That all sounded very imposing. Sobby, with bulging eyes, watched the

proceedings carefully. John lit a cigarette and gazed at the ceiling. He had seen them demonstrated before.

"It's simple, folks," reiterated the salesman. It looked simple. It had more dials than the safe in the first national bank. It took an ingenious man to break into that first national bank safe, but to make this thing work was going to take a super-genius genius, if there is any such animal. Probably not.

"Now, we'll set the first condenser," he said enthusiastically. He did. Nothing peeped.

"Oh, hell," he grumbled; "beg pardon, ladies. I forgot to turn on the juice."

The so-called juice was turned on and the tubes glowed.

"Ha-ha," he laughed. "Now we're all right."

He revolved the first condenser and set it at seventy. "Who-e-e-e," came from the loud speaker.

"Ha-ha," he chortled. "There's something on the air—there's something on the air!"

Whatever it was, it had a painful way of showing it.

"Now we'll set the three variometers. This is the plate variometer and this is the grid variometer and this one controls feed back. Now, you see, this first condenser acts as a sort of wave trap, while this condenser over here tunes the third radio frequency transformer."

"Well, how do we know which is the condenser and which is the vary-oh-meter?" inquired the ticket seller. "All the dials look alike."

"Well, we give you a book and you memorize it," replied the salesman. "Now watch. This ought to be Kansas City, here."

"Roe Searsbuck," grunted John.

He turned the dial that turned the grid variometer. "Who-e-e-e." He turned the plate variometer. "Two--weet." That made two "Who-e-e-e's" and one "Two--weet." So far, so good. Turning the feed back variometer, the loud speaker emitted a screech and the lady ticket seller almost jumped out of her makeup.

"The detector rheostat is a little critical," explained the salesman, turning the rheostat in question. "Now we'll tune in the station." He moved this dial a little, this one a little, the radio frequency rheostat was adjusted a little, then the second condenser dial was adjusted a trifle, and the onlookers watched him with bated breath, expecting a burst of music from the Civic Opera Company. Every adjustment was accompanied with a screech or a whistle or a shriek. But music—"Two--weet." Well, that was something.

"Maybe you're aunt-annie is disconnected," volunteered the car washer.

"The aerial is O. K.," said the salesman. "All good sets are critical in operation. You have to get the hang of

tuning them, that's all. It's simple—when you know how."

"Where did you learn?" inquired the piano tuner somberly, meaning no levity. He was a seeker after knowledge.

"In the best radio shop in the world—see!" The salesman growled that kind of snappily. The first rule of good salesmanship is to keep smiling and don't let anybody go south with your Angora, but it looked as if this salesman was very sensitive; more so than his radio set.

After five minutes of adjusting big dials and little dials, not to mention a potentiometer, the loud speaker sighed. Ah! The salesman perked up.

"There is something!—there is something!" cried the salesman. Evidently that sigh was a clue.

Each dial was critically adjusted and then—first like a man speaking with a bad cold and through his nose, there came from the loud speaker the unmistakable sounds of a human voice. It became clearer and clearer and finally burst forth so you could understand a word here and there.

"There we are, folks," said the salesman, spreading out his hands. "As I said a second ago—it's simple."

That was a long second, but why argue over nine minutes and fifty-nine seconds? Everybody gave a long sigh.

"Gosh!" said the El conductor. "I didn't think he'd make it."

"TwinkletwinklelittlestarhowIwonder whatyouare?" lisped a childish voice through the speaker, sans punctuation or sans everything, even expression.

"What station is that?" asked the lady from the novelty store.

"Kansas City, I said," snapped the salesman.

"Roe Searsbuck," grunted John.

"I tell you, it's Kansas City!" flared the salesman. "Here's the announcement."

"Blah, blah, Ell Ess, the Roe Searsbuck station broadcasting from our Hotel Mansher studi-oh. You just heard little Myrtle Turtle recite a piece of poetry. Little Myrtle is only five years old and will next recite Paul Revere's Ride. Blah, blah, blah Ell Ess, Shi-caw-go-oh."

John grinned. "That'll be enough o' that," he stated to the salesman.

"Wait!" cried the salesman. "I'll tune in a long distance station."

"In the day time!" John grinned. "Well, hurry up."

The salesman fiddled with the dials in the region of the thirties, and each twirl was accompanied by a screech. Then the speaker sighed.

"Ah!" exclaimed the salesman. "This should be Havana."

"Daily Snooze," grunted John.

"I'll bet it's Havana. If it isn't, I'll take my set right out of here."

"Daily Snooze," grunted John.

"Rabbit Maranville at bat," came through the speaker. "Three balls and

two strikes, two men down. Nehf pitches the ball. Rabbit knocks a high fly to center field and is out. Last of the fifth. Score two and. This is the Daily Snooze station—"

The salesman looked sheepish and disconnected the "aunt-annie."

"Well, what do you think of the set?" he asked the janitor.

"Rotten," replied that worthy. "Why say, listen. I got a crystal set home that gets all that stuff and I don't need five hands to tune it. Razzberry, bo—razzberry. Take it back—it's all damp."

The "listeners-in" all giggled and drifted out. The salesman disconnected a multitude of wires and carried his set out to a car.

"That isn't such a rotten set," said Sobby.

"Too many controls—too many controls!" snapped John. "You gotta be a centipede to tune the darn thing. You got a set?"

"Not yet. This thing here looks pretty nifty. What is it worth?"

"Listen!" said John, in a didactic tone of voice, if that can be done. "Don't buy none o' these tailor made sets. Build your own. There ain't no fun in them. The joy is in creating something. Boy, after you roll your own an' she works—that's where the kick comes in. Roll your own."

"You think I could roll my own?"

"Why, sure!"

"And she'll work?"

"Absolutely! I kin sell ya all the parts an' give ya a pitcher an' ya can't go wrong. Look!" Out came the "pitcher." "You need two variometers an' a twelve fifty honey comb coil—"

"Ah-ha."

"—an' one socket, one rheostat—"

"Yeh-yeh."

"—an' one tube, six binding posts, piece o' panel—I got 'em all drilled— an' a coupla pieces o' bus wire, electric solderin' iron, a little solder, four dry cells an' a 22 volt B battery. That's a autoplex . . . What? I don't know what the hell it means, but, if you want volume, this is the baby."

"Fix me up," said Sobby, reaching into his pocket. "And gimme two o' those pictures."

So Sobby staggered back to Oak Park with a load of junk that pulled him stoop-shouldered. Soon he would be an expert.

SOBBY lived with his wife, Dorothy. Lived is right. She used to be a hat checker in a hotel in which he had sobbed. The front of her head was beautiful, but the top—ceramics. Beautiful and, or but, dumb. They lived in a Queen Anne bungalow and lived serene lives, minus any quarrels or excitement. She didn't have enough gray matter to give him a snappy comeback to anything he might say. Whe.

(Continued on Page 52)

Short Wave Reflection Phenomena

An Analysis and Simple Explanation of the Reasons Why
Short Waves Travel Further Than Long Waves

By *Everett W. Thatcher*

OUR attention is increasingly being directed toward the remarkable results that have been attained on the shorter waves. Phenomenal distances are being bridged on very low power. Consistent communication, day and night, is being maintained over distances which a short time ago were granted possible only to the super-power long wave stations.

There have grown up with this development several problems as to the nature of the propagation of radio waves at high frequencies, corresponding to the waves below 100 meters. The complete "reversal" of many of the conditions which were known to exist on the higher waves has necessitated the investigation in the light of past experience of the new phenomena. A word of introduction will suffice in mentioning some of the generally accepted conceptions of the propagation of the lower frequency oscillations.

For many years it has been an established fact that radio signals covered greater distances at night than they did when the sun was shining brightly overhead. The natural thing to do was to blame the sun for cutting down our range, and this was done in a most satisfactory manner. The rays of the sun had been shown to have certain ionizing powers such that under their influence the atmosphere became a partial conductor of an electric current. Its effect then, was to soon neutralize the electromagnetic vibrations of which the radio waves were composed, and thus the

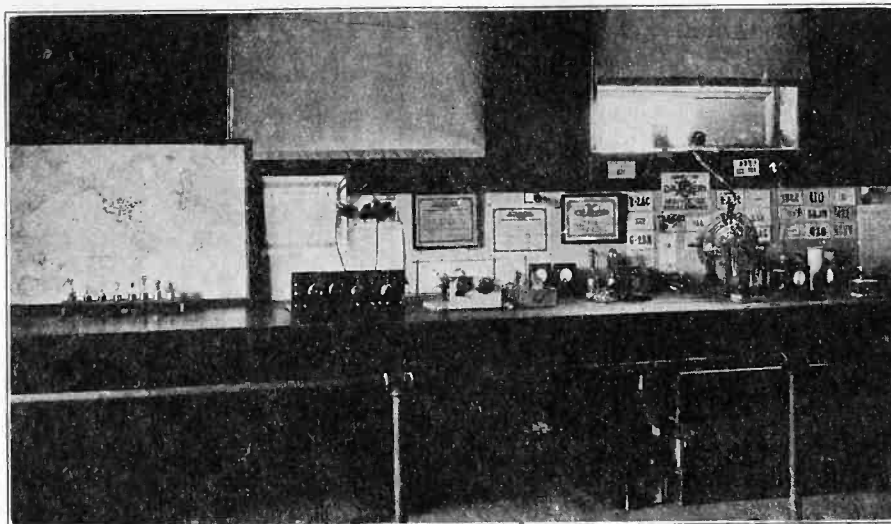

Station 8ZE-8XT, Physics Laboratory, Oberlin College, Ohio, Where Experiments Are Being Conducted.

range of the station was materially decreased.

Experimental observation has also shown that as we go outward from the surface of the earth (and the atmospheric pressure becomes less and less) there is a gradual increase in the ionization of the atmosphere. That is, the number of ions per unit volume of space becomes increasingly great. Our reasoning then extended shows us that at a certain height above the surface, where the atmosphere is so rare that it exceeds the most perfect vacuum which we can produce in the laboratory, there must exist a layer of permanently and completely ionized space.

The form of this layer could be pictured as that of a great conducting

sphere completely surrounding and enveloping the globe. It is natural to suspect that such a stratum of conductivity as this should materially affect the waves of radio signals. It is just this effect, particularly upon short waves that it has been the writer's privilege to investigate.

The assumption that radio-energy undergoes the effect of refraction and ultimately reflection at this layer has seemed to account very satisfactorily for many of the phenomena which characterize experimental short wave work. It is also in accordance with the fact that radio waves are a form of electromagnetic radiation, as is light though of much longer wavelength, and that as such, they have been shown to follow the same laws of reflection and refraction as light with whose actions we are more familiar.

We will therefore consider briefly an analogous situation in the realm of light and show how the laws applied to the field of radio would produce exactly the phenomena which are observed.

When a ray of light, for example, strikes the boundary between a poor conductor and a good one, part of the light is reflected at an angle equal to the angle which the incident ray makes with the perpendicular to the surface, and part is refracted or bent away from the perpendicular as it passes through. The angle of the refracted ray to the perpendicular increases as the angle of incidence is made larger—but at a faster rate. It is evident that for a certain angle the refracted ray will emerge parallel to the surface of the water. Beyond this angle, known as the critical

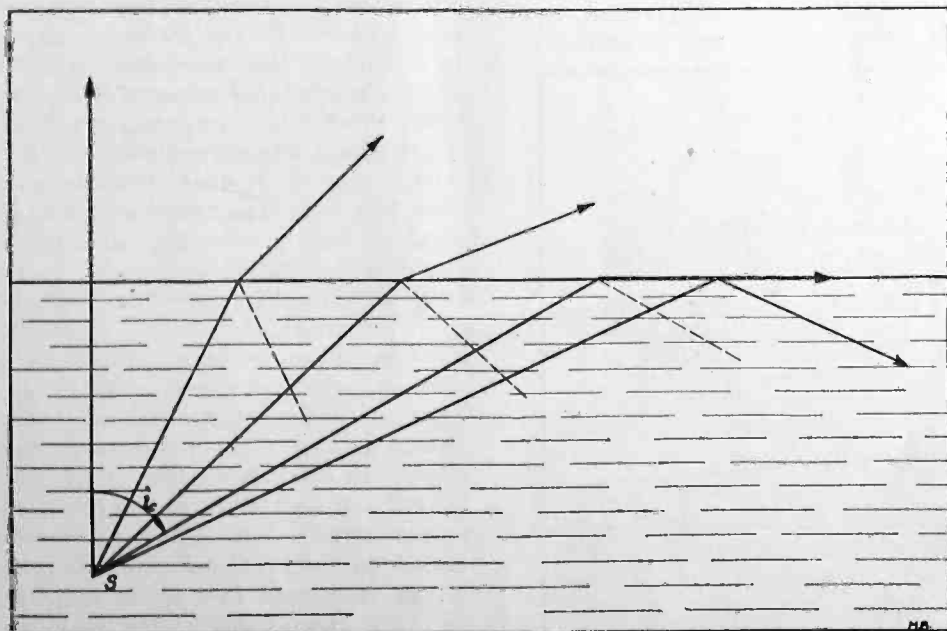

Fig. 1. Refraction and Reflection of Light Waves.

angle, all of the light is reflected. (Fig. 1). The value of the critical angle is dependent upon the ratio of the index of refraction of the liquid to that of air, and this index, generally called μ is in turn a function of the wavelength of the incident light.

It is true that the boundary conditions met with in the reflection of radio waves are not in all probability sharp and clearly defined as is the surface of a liquid. Instead the change of conductivity takes place more or less gradually. The only effect of this difference on the wave is to round off the sharp reflection angle so that what we actually have to deal with is a curve rather than the sharp angle (indicated by the dotted line). This does not in any way detract from the value of this theory in the explanation of present phenomena and the prediction of future possibilities.

Above 150 meters it has been impossible to measure the effects of the reflection of wireless waves from the Heaviness side layer. It is highly probable that reflection occurs, but there are two reasons which stand in the way of its detection and measurement. First, the critical angle is so small that the reflected waves are returned quite close to the source. Second, the direct waves from the station travel greater distances before being absorbed.

We may again conveniently borrow an analogy from light. Ordinary glass allows all the colors of the visible spectrum to pass through almost unimpeded. We call it transparent, and say that we can see through it. However this same glass is an effective barrier against the invisible extremely short waves of ultra-violet light. In some such way as this, the longer waves are enabled to travel directly, a much greater distance than the short waves, the latter suffering absorption in the earth comparable to that of the ultra-violet in glass.

It is also true that absorption due to resonance with the natural period of surrounding objects is much greater on short waves. There are many more ob-

jects, buildings, trees, and the like which have a fundamental near 40 and 20 meters than on the 80 or higher bands.

Such effects as might be observed then on the higher bands are "covered up" by the direct impulses from the transmitter. The total energy at the receiving station is the sum of the re-

tance, or the extremes of range for both day and night.

At the writer's station, the experiment was extended over a period of five months during which time some 700 stations were worked. It would be possible to count on the fingers of one hand the stations worked inside of 180 miles—and the few that were heard were

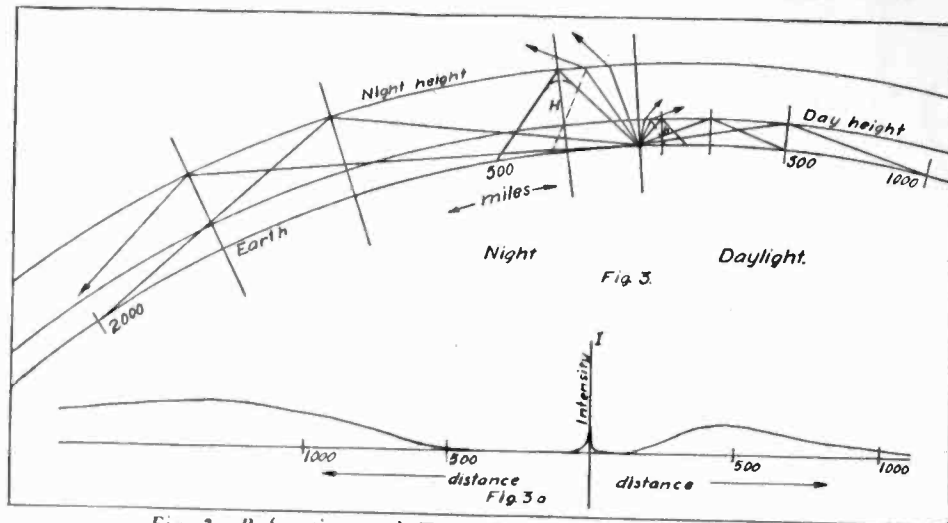

Fig. 3. Refraction and Total Reflection of 40 Meter Signals.
Fig. 3a. Resultant Audibility Curve.

flected and direct energy. The audibility curve (Fig. 2) shows the alignment of these two values against distance for a 200 meter signal.

On the 80 meter band a rather surprising effect is noticed. Signals within a radius of 100 miles, while maintaining good audibility during the day seem to fade at night and are as a rule much weaker than signals from several times as far. In general, however, they are not inaudible.

When the wavelength is decreased to 40 meters, the effects of reflection become sufficiently great that measurement of them is rendered possible. This is done by taking a representative period of time and carefully recording the distance of each station heard or worked during the period. If it be of sufficient duration to meet all possible conditions, there may be found the average minimum distance and average maximum dis-

weak and faded badly. The same might be said of stations more than 1000 miles distant, though many were worked at nearly this distance with good audibility.

At night it was a different story. Stations within 500 miles were seldom heard, and beyond that the signal strength seemed to increase with the distance, the best signals coming from stations over 2000 miles distant. The operation of the transmitter was similar in every respect, and more stations in the sixth district were worked than in any other during the hours of darkness.

The results of experiments on 20 meters have shown in the same way that the daylight range is from 850 to 2500 miles or better, while at night, 2500 miles seems to be the minimum distance.

Now, as to the cause of the marked differences between the day and night ranges of the 40 and 20 meter signals: It is evident that the waves from the average minimum distance will represent those which have been totally reflected. Thus they define the point at which the critical ray is returned to the earth. (See Fig. 3). The reflection then must occur in such a way that the 40 meter signal, for example, is brought back to earth at 500 miles at night and 1800 miles during the day. At points closer than the average minimum distance from the station, only a comparatively small amount of the energy is received, as could be seen from the analogy with light. By far the greater part is refracted and lost. The maximum is governed by the absorption of the vibration in the partially ionized atmosphere,—it is not connected in any essential way with the critical angle. In every case the angle of incidence is larger than i_c .

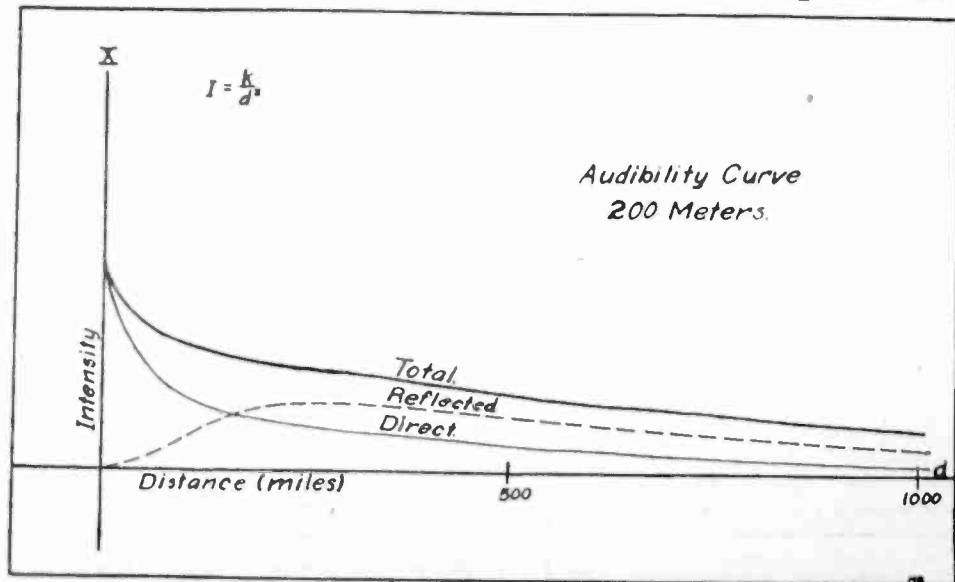

Fig. 2. Decrease of Audibility with Increase in Distance.

and the conditions for total reflection are present.

By undergoing repeated total reflection from the layer the short waves are enabled to reach points at any distance around the curve of the earth, even to the antipodes.

The critical angle, dependent as it is only on the wavelength, will be of the same size, both day and night. That is the critical ray will strike the ionized

present in addition to those already considered between darkness and light.

There remains the correlation of the results of many experimenters in different parts of the world, and under varying seasonal conditions. It is to that end that the present work is being presented.

We are led to wonder just what will be gained by operating on the shorter waves, if by doing so we place between

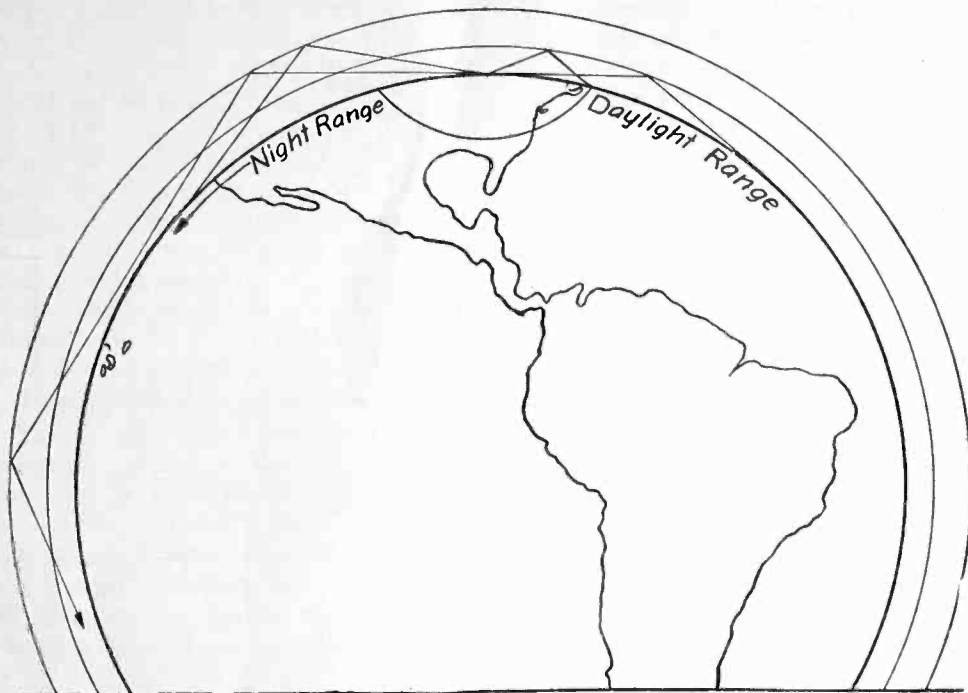

Fig. 4. Total Reflection of 20 Meter Signals.

layer at the same angle in each case. With this in view, we can see that the effective height of the ionization under the influence of the sun will be about one-third of its height at night.

The fact that twenty meter signals are reflected at a critical angle greater than i_c for forty meters is evident since the daylight range of the twenty meter signal is 850 to 2500 miles and the night range in excess of 2500 miles.

It is of interest to note the agreement which these results have given in the experiment at the writer's station. These results are summed up in the table below:

80 Meters (3750 K.C.)	Night	Day
Average minimum range	75 miles	0 miles
Average maximum range	5000 miles	200 miles
Ratio H/h
40 Meters (7500 K.C.)		
Average minimum range	500 miles	180 miles
Average maximum range	10,000 miles	1000 miles
Ratio H/h	2.80 to	1.0
20 Meters (15000 K.C.)		
Average minimum range	2500 miles	850 miles
Average maximum range	10,000 miles	2500 miles
Ratio H/h	2.94 to	1.0

The figures given here represent the results of the experimental work at one particular station, during a particular period of time. It is now quite evident that there are strong seasonal changes

ourselves and our neighbors an effective barrier to all local communication. The answer is found in many of the up-to-the-minute amateur stations throughout the country. A transmitter and receiver, flexible over either of three bands, twenty, forty, and eighty meters. Then, using reflection phenomena to advantage, consistent communication may be maintained over any distance, at any time of the day or night.

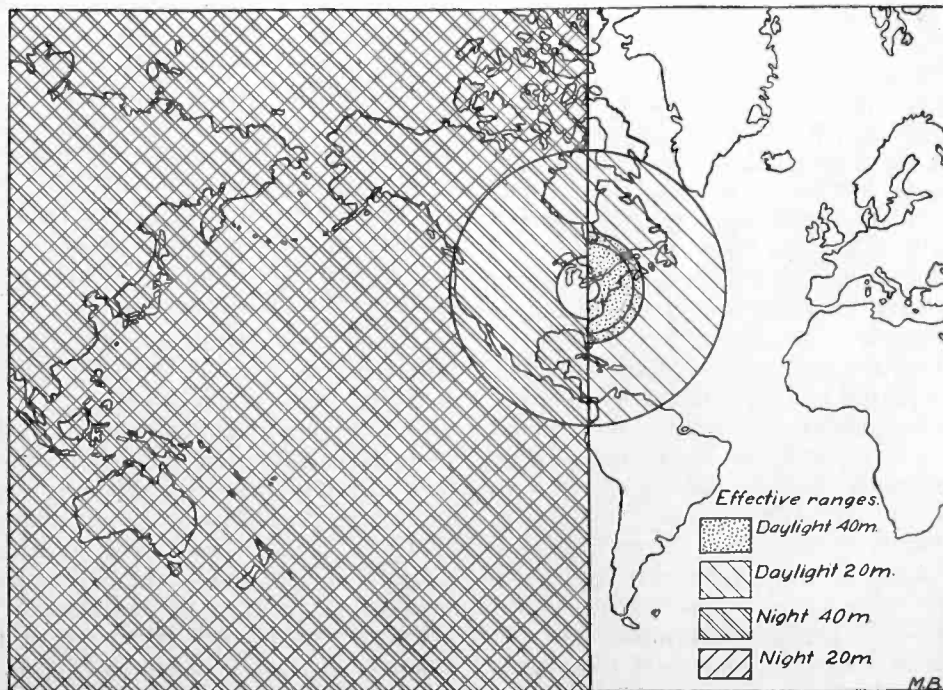

Fig. 5. Approximate Ranges to Be Expected from Efficient 40 and 20 Meter Installations. An 80 Meter Wave Is Necessary to Close the Gap Adjacent to the Station.

COIL DOPE

By G. F. LAMPKIN,
8ALK, "FO"—8CAU

THERE are only two reasons for using dope on a coil; one, is to obtain mechanical rigidity and permanence, and the other, is to obtain freedom from harmful moisture effects. These are both distinct advantages; so, naturally, if the disadvantages are not so distinct, it is better to use than to do without dope on a coil. The disadvantage of using dope is that it raises the distributed capacity of the coil; in effect, placing a very small, but also very punk, condenser across the coil, and playing hob in general with low losses. Some dope may actually absorb moisture, and moisture will intensely aggravate the above troubles. So it may be seen that there are dopes and dopes, and the only way to get anywhere is to do some measurement work.

Five identical coils were made—each of 34 turns of No. 28 d.c.c. wire, close-wound on a 1/16 in. micarta tube, 4 1/8 in. outside diameter and 1 5/8 in.

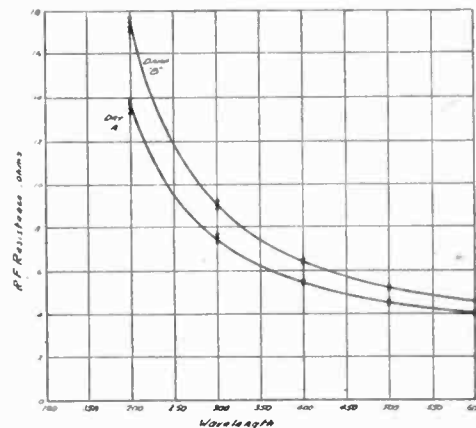

Fig. 1. Average R. F. Resistance of Coils.

long. No attempt was made to construct low-loss coils, as such was not the object of the test. Each coil had

an inductance of 202.5 microhenries at 500 meters. The coils were thoroughly dried, by baking for several hours, then measured for radio-frequency resistances at wavelengths from 200 to 600 meters. The results of these measurements are shown in Curve "A" of Fig. 1. It is the average-resistance curve for all the dry coils. The greatest deviation of any coil from the average, at any point, was 2.5%.

The coils were then placed in an airtight container in which the humidity was kept, by means of steam and hygrometer, above 95%. After being exposed to this moisture for 24 hours, the coils were taken out and again measured for radio-frequency resistances, and the average curve, "B" of Fig. 1, obtained.

It is seen at once that moisture has a very deleterious effect, and that this effect, with any given coil, increases as the wavelength is shortened. It is not to be supposed, that, because the coils were exposed to a relatively high humidity, exposure to a lower humidity would cause no harm. The high humidity was used in order that the time necessary for the tests would be shortened. This high humidity, acting on the coils for 24 hours, caused a maximum increase of resistance of 28.2%. The natural humidity of the room, acting for two weeks on another coil (45 turns of No. 24 d.c.c. on 3 in. tube), caused the resistance at 200 meters to increase 21%. Thus there is need for a dope which will minimize the harmful effect of moisture.

Incidentally, it may be seen why some coil measurements of radio-frequency resistances cannot be made to check from day to day. The blame may be placed on the changing humidity. The only way to obtain accurate results is to dry the coils before measurement. All resistance measurements in these tests were made by the resistance variation method, using a Weston Model 425 Thermo-galvanometer, a General Radio .1 to 100 ohm decade resistance, and a .0005 mfd. capacity-calibrated Cardwell condenser, in the measuring circuit. A 50-watt local oscillator was used as the source, removed 10 ft. from the measuring circuit, and coupled to it through twisted pair and a 3-turn coil. The measuring circuit was grounded between the meter and the rotary plates of the condenser.

The next thing done in the tests was to dope the coils and to learn how they behaved under the same conditions as before. Accordingly, all coils were dried until their resistances returned to the initial, dry, values. Collodion, paraffine, shellac, No. 17 varnish, and a 50-50 mixture of beeswax and rosin were chosen as representative dopes. Each coil was covered inside and out with its respective dope, and thoroughly baked; then was measured for radio-frequency resistance.

The percentage increases of doped,

dry, resistances over the undoped, dry, resistances were somewhat erratic, several of them dropping below zero; that is, the resistance of the coil, doped, was less than that undoped. This is hard to explain, unless the coils when measured undoped, and supposedly dry, were not completely free from moisture. Also, when working with resistances around 5 or 6 ohms, a different of .1 ohm, the lowest division of the decade resistance, will change the percentage value considerably. The curves show clearly, however, that the beeswax-rosin mixture increases the resistance less than the other dopes; and that what harmful effect it has is con-

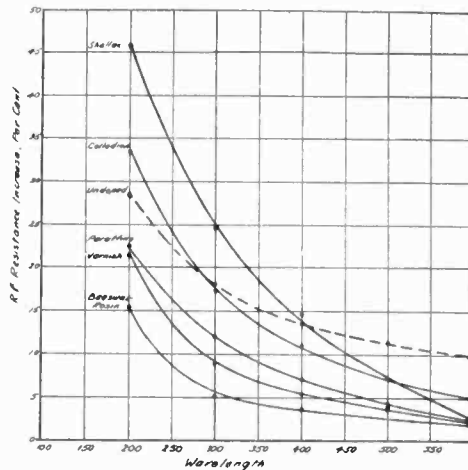

Fig. 2. Increase in R.F. Resistance After Doping, Baking and Exposing.

finied to the shorter waves. The other dopes increase the resistance, more or less, at all waves.

The doped coils were then subjected to the 24-hour treatment at a humidity of 95+%. And again, measuring resistances, the curves of Fig. 2 were obtained; the percentage increases of doped and damp coil resistances over the undoped and dry coil resistances. The beeswax and rosin mixture again stands as the best dope. Such a mixture was first used some years ago in the spectacular high-frequency, high-voltage outfits, and was the only insulation which would stand up. The heavy dotted line shows how much the humidity treatment increased the undoped-coil resistances. Any doped coil which shows an increase higher than this line, is worse than useless, for the coil is better without the dope. Collodion and shellac fall in this class.

These results, while obtained for only one particular size and shape of coil, are without doubt applicable to practically all other types of radiocast coils. A dry, undoped coil is better than the same coil dry, and doped; but the difficulty comes in keeping the coil dry. In any ordinary weather, the coil will tend to become damp, and here the correctly doped coil has the advantage; in addition to the other first-mentioned advantage of mechanical rigidity. Correctly doped, as has been seen, meaning a 50-50 mixture of beeswax and rosin on both inside and outside of the coil.

THE WONDERFUL BATTYOMETER

(Continued from Page 16)

what-nots, even as Steinmetz and Edison. And hath not even the great radio correspondence college presented him with a golden certificate, with a seal not surpassed even by his father's wildcat oil stocks, in evidence of his exceeding goodness? Indeed, he shall be my pride and joy forever, and a credit to the house of Ham." And the family indeed is greatly awed, even unto little sister and big brother.

At last he goeth up before the Great Council, even to the office of the Radio Inspector. And he beardeth the lion in his den, and saith to him, "Give to me what I seek, for all radio's secrets are revealed to me. Bestow upon me the white ticket, for I, too, would be a commercial operator and handle the world's traffic, even that of the Radio Corporation. Do this for me, and unto thee shall be given great praise and thanks."

The Inspector seateth him before a table, and in his hand he placeth a pencil, and before him a paper, and unto him saith, "Copy thou that which thou hearest." And he turneth on another Battyometer like unto the one of the Ham, and he indeed burneth up the contacts thereon, the speed thereof so great. But the Ham flincheth not before the onslaught, but copyeth bravely and well. The Radio Inspector is well pleased; he saith unto the Ham, "What wouldst thou do if thou heard an SOS?" And the Ham saith, "At once would I send a news dispatch to the Associated Press, and demand of the captain of the ship in distress a ransom. And if he agreeth thereto, would become a hero and occupy the front page in many headlines. Deserveth I not a license?" And the Inspector saith, "Indeed, thou deserveth much," and issueth unto him a triple extra license of exceeding worth.

And it came to pass that, as the years of his studying were spent, he looketh up and down the land, in search of a position, even a berth. And at last he cometh to a place called San Francisco, in the land of California, and there findeth a ship in want of an operator. He goeth to the captain of the vessel and saith unto him, "I am he for whom you seek. Turn me not away, for I am a brass-pounder of the first water, not to mention par excellence. It is I who will spend the weary hours on watch in the radio cabin and collect the daily press. And am I well qualified? And have I a gilt-edged diploma and a triple-plate license? Yea, indeed, should I hope to snicker!" The captain is duly impressed, and mightily pleased. He bestoweth upon the Ham the holy robes of operatorship, and maketh for him a place in his own radio cabin, and calleth him "Sparks." And the ship saileth for the far land of San Diego.

(Continued on Page 28)

A Battery Charger Resistance Unit

By Harry R. Lubcke

It is often desirable to reduce the rate at which a battery is being charged. If only one or two cells are being charged with a rectifier designed for three cells the rate will be abnormally high and detrimental to both charger and battery. Since the current which must be carried by any resistance is large, an ordinary receiving tube rheostat cannot be used. The current varies from about 2 to 5 amperes, depending on the type of charger, and is enough to "burn up" the ordinary unit. Power tube rheostats may be used, but these are expensive and are not found in the average fan's equipment.

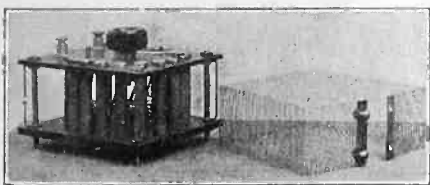

Fig. 1. Battery Charger Resistance Unit With Wire Netting Removed.

The rheostat shown in Fig. 1, however, will carry up to 5 amperes without excessive heating and can be easily constructed with materials readily available. The resistance is furnished by 15 large size flashlight battery carbons. These are held between two pieces of bakelite in snug-fitting holes; the number in circuit being varied by the switch shown on top.

The carbons used in the author's unit measure 2 1/4 in. long by 5/16 in. in diameter. The caps should be intact, since they form the switch points over which the switch arm travels. They can be obtained from large dry cell B batteries as well as from flashlight batteries.

The two pieces of bakelite required can generally be salvaged from by-gone sets as their thickness is immaterial.

The pieces, measuring 4 by 4 1/4 in. are drilled as shown in Fig. 2, which gives the constructional details. With the exception of the holes near the bottom for the binding posts and switch stops the two pieces are drilled exactly the same. In order that the holes may coincide it is best to clamp them together and, laying out the holes on the top piece, drill through both at the same time. Small holes about 1/16 in. in diameter are drilled adjacent to each carbon rod hole as shown, through which the connecting wire from the bottom of one rod to the top of the adjacent one are passed.

The two bakelite pieces are held apart by spacing rods as can be seen in Fig. 1. These are pieces of 5/32 in. diameter brass rod which are threaded at each end. The holes in the bottom piece (No. 28 drill) were threaded with an 8/32 tap so that the rod could be screwed in place and locked with one nut on the bottom. The holes in the top piece must be large enough to allow the rods to slip through (No. 19 drill) and the piece held by two nuts, one top and bottom, so that the distance between pieces can be adjusted. As will be noted the rods are 2 1/2 in. long which allows for 3/8 in. projection from the bottom piece. These act as feet, raising the resistance rods above the object on which the unit is placed.

In the original model the carbon rods were copper-plated at the bottom and the connecting wire soldered thereto. This, however, is not advised, since it decreases in a large measure the "contact resistance" between the carbon and connecting wire and lowers the resistance of the unit too much.

For example, it was found that the resistance of one carbon rod was 0.2 ohm when held between battery clips. Hence

15 in series should have 3.0 ohms resistance. When the unit was made up, the rods being plated at the bottom, the maximum resistance was only 0.78 ohms. It is desirable that this be from 3 to 6 ohms for ordinary work. Therefore, the copper connecting wires between rods No. 12 to 15 were taken out and resistance coils wound of ordinary 5 ampere heater coil wire were put in their place. The coils were wound non-inductively and were made self supporting. The maximum resistance is now 6.26 ohms.

If then, a higher resistance is desired than can be obtained with the rods alone the coils can be added. The ordinary electric heater wire has a resistance of about 1 ohm per foot (1.15 ohms to be exact) so that the length needed can easily be computed. The wire is doubled upon itself and wound on a conical form, the two strands being wound side by side but spaced about the width of the wire. The middle of the length is wound on first at the small end of the form (which can be a piece of dowel or pencil sharpened to a point) the winding continuing up the form until the ends of the lengths are reached. The loop at the beginning of the coil is pushed through a hole suitably provided in the lower bakelite piece while one end is connected to the bottom of one rod and the other to the top of the adjacent one. A finished coil is shown in Fig. 2.

To get back to the carbon rods. It is recommended that where copper connecting wires are to be used instead of auxiliary resistance coils, as for example, near the beginning of the series where it is desirable to have the resistance increase in small steps, that No. 18 bare wire be used. This is wound around the bottom of the first carbon for two complete turns and made tight by twisting the free end around the main length. The main length is then brought through the hole provided in the lower bakelite piece and up, diagonally, through the hole in the top piece adjacent to the second carbon rod. It is soldered to the cap of the second carbon rod and also at the bottom of the first one. It cannot be soldered to the rod but the solder keeps the turns rigid and together, duplicating, after a fashion, the cap that is found on the top. This process is continued around the circle of rods, thus connecting them in series, resistance coils being interposed between the last ones if desired. The cap of the first carbon rod is connected to one binding post and the switch to the other. The bakelite pieces and spacing rods are assembled and the carbons are put in place before the wiring is done. Care should be

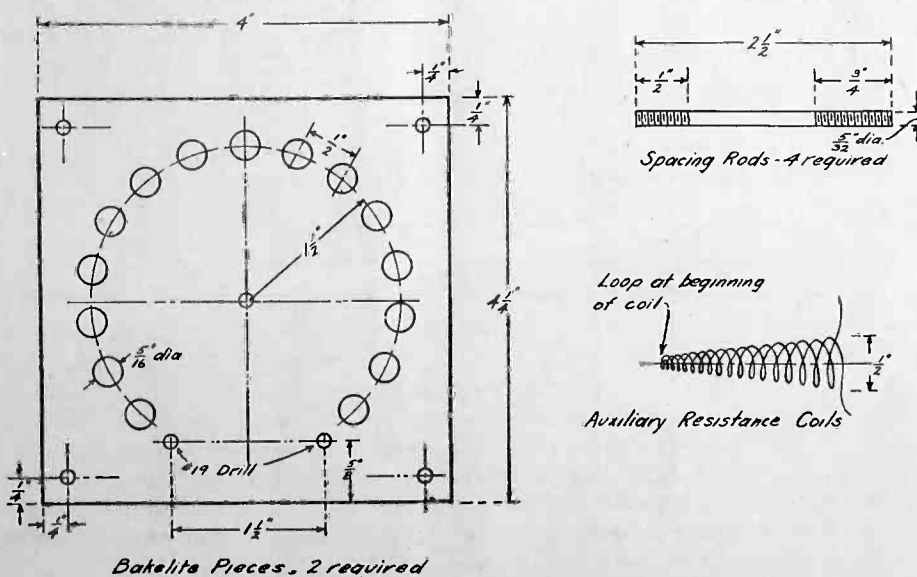

Fig. 2. Construction Details of Resistance Unit.

taken to see that the carbons fit snugly in the holes provided for them.

The switch may be of the 5-10-15c store variety or any one at hand that has a blade about 1 1/2 in. long. The connection from the switch to the binding post is a piece of copper strip 1/4 in. wide by 1/32 in. thick drilled at each end so as to fit over the switch shank and binding post bolt.

In order to inclose and improve the looks of the unit a screen of copper netting was provided. A piece 13 in. long by 1 5/8 wide is required. If possible it should be cut from the outside edge of a roll as this edge is "finished" and does not fray. The other edge can be kept even by first applying a slight amount of soldering flux and then running a

well tinned soldering iron around it, which solders the end wires together.

Two pieces of copper 3/8 x 1 5/8 x 1/32 in. are soldered to each end and drilled with a No. 28 drill top and bottom to pass two 6-32 screws. Two 6-32 thread nuts are soldered on the back of the inside piece so that the netting can be screwed together from the outside with a screw-driver. The netting is stretched around the spacing rods which hold it at the four corners. The holes in the outside copper piece should be elongated so that the netting can be stretched tight as the screws are tightened.

The resistance required is governed by the make of charger and the charging rate desired. The greater it is desired

to decrease the charging rate the greater the resistance must be. In most cases the series resistance necessary to secure various charging rates can be secured from the manufacturer. The unit can be used to cut down the charging rate to a small value and "trickle charge" the battery, as is now coming to be so popular. About 6 ohms resistance is generally required for this work.

The rheostat is connected in series with the battery. That is, one clip is fastened to the battery as usual. The other, which would normally go to the battery, is connected to one binding post on the rheostat. A wire is fastened to the other binding post and its other end connected to the remaining battery terminal.

A Single Control All-Wave Four-Tube Receiver

By *McMurdo Silver*

WITH single control achieved by interlocking two condensers having substantially straight line frequency curves and a practical range from 50 to 1800 meters accomplished with various plug-in inductance coils, a four-tube receiver recently developed by the author and L. M. Cockaday adequately meets all of the requirements of the average constructor of home-built sets. The circuit as shown in Fig. 1, employs one stage of tuned radio frequency amplification, regenerative detector and two stages of audio frequency transformer amplification.

In preliminary tests 34 stations were logged with a loud speaker between 9 and 10 p. m. in a residential section of New York City and later in the evening KFI was clearly heard. Its selectivity and adaptability to different antenna lengths and locations is controlled by a

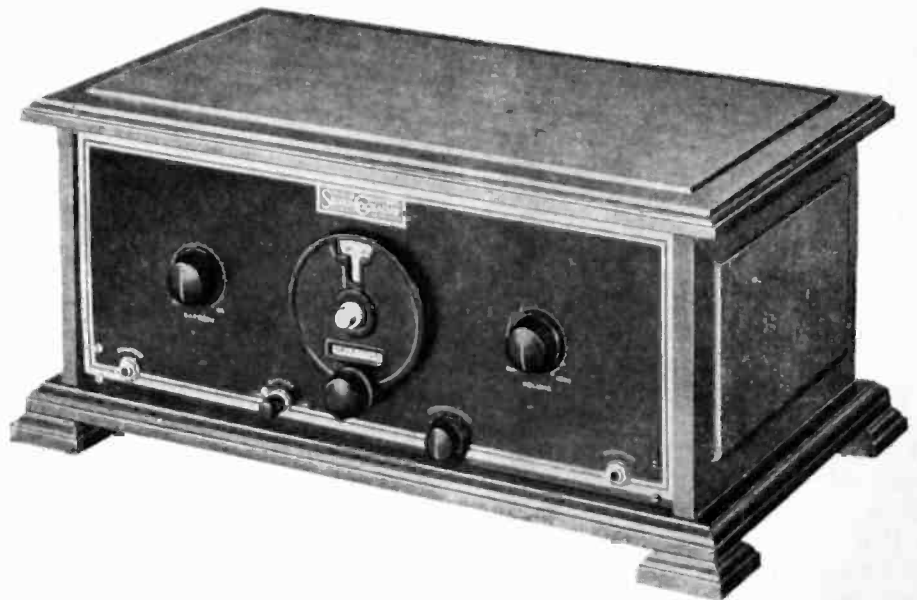

Panel View.

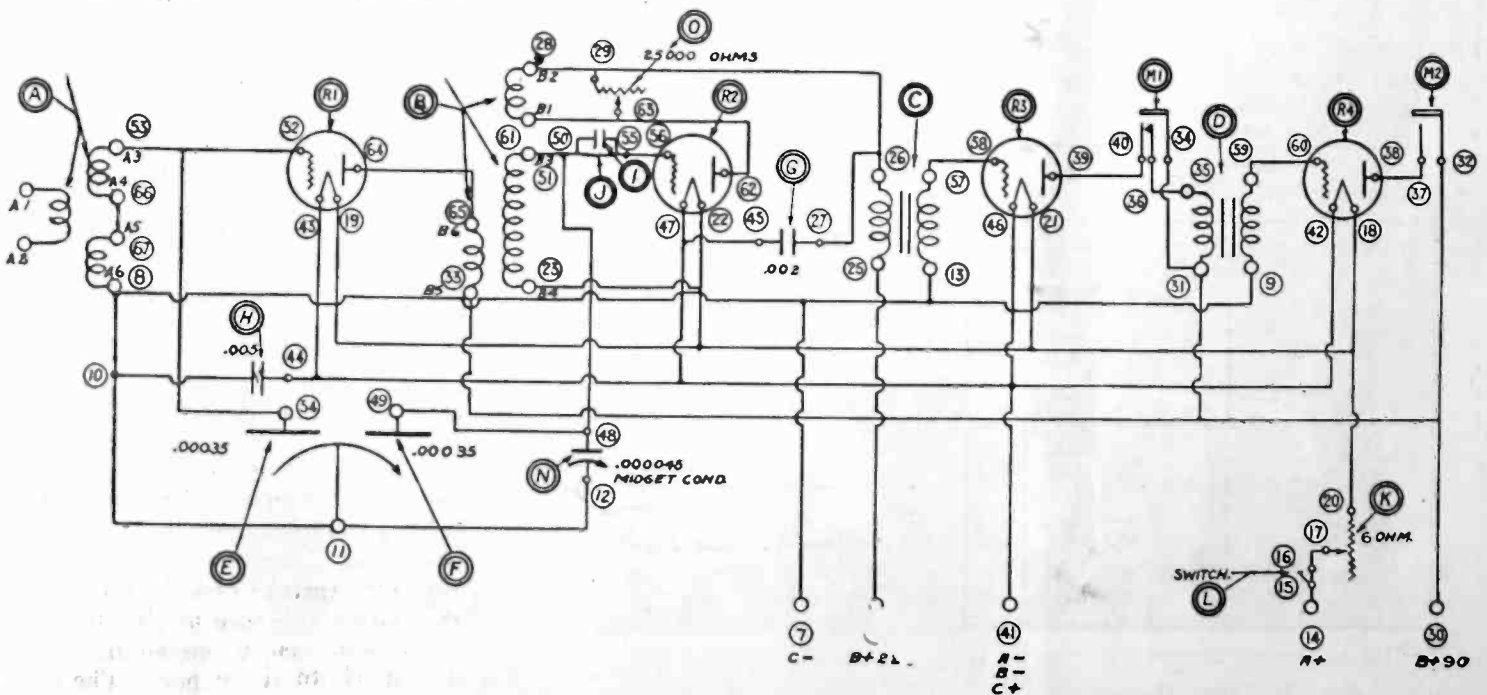

Fig. 1. Circuit Diagram for Single Control All-Wave Four-Tube Receiver.

small coupling coil in the antenna inductance.

The total cost of the parts listed, including the panel, is less than \$60. Other equivalent parts may, of course, be substituted. The designating letter in the list of parts corresponds to those shown in the pictures and diagrams.

The wiring harness is an especially unique feature for the novice constructor. Soldering is not absolutely necessary as the wire ends may be fastened with thumb-nuts or squeezed tight on the lugs. More care should be exercised in the placement of parts if the harness is used than if the more conventional wiring is employed.

After the panel and sub-panel have been drilled in accordance with the dimensions shown in Figs. 2 and 3 respectively, the first operation is to mount the sockets for inductance coils *A* and *B* on the upper side of the sub-

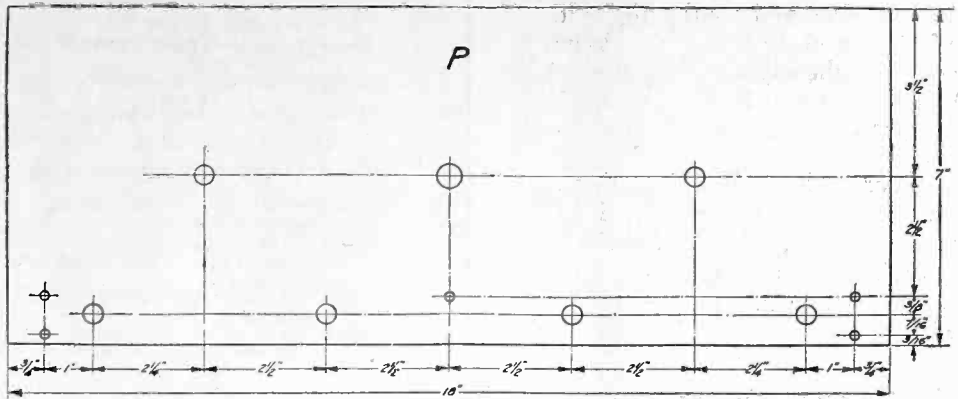

Fig. 2. Layout for Main Panel.

mounted one behind the other at the center of the upper side of the sub-panel. The shaft of one projects over the edge of the sub-panel so as to fit in place in the front panel.

Next the two jacks M_1 and M_2 , the battery switch, the small compensator condenser *N*, the battery rheostat *K*, the

dent from the pictures and diagrams. With one tube in the socket and the *A*, *B* and *C* batteries connected the set is ready for test.

Assuming the tube to light properly, and its brilliancy to vary with the adjustment of the rheostat, the three remaining tubes should be put in their sockets. If a power tube—UX112 or UX120—is used, it goes in socket R_4 . For UX199 tubes, the rheostat should be just barely turned on, while for UX201A's it should have the indicating arrow point to the right. The loud-speaker may be plugged into either of the jacks.

So far, the antenna has been ignored. It should consist of a single wire about 70 to 100 ft. long connected to post A_1 or A_2 of coil socket *A*. An indoor antenna can be used, with a decrease in sensitivity, however. The ground, connected to whichever post— A_1 or A_2 —was not used for the antenna, should consist of a wire run to a well-scraped water pipe.

In preliminary tuning, condenser *N* is set at zero (left), and the volume knob at zero (left) then if the selector dial is rotated, local stations if operating, will be heard. The selectivity of the set

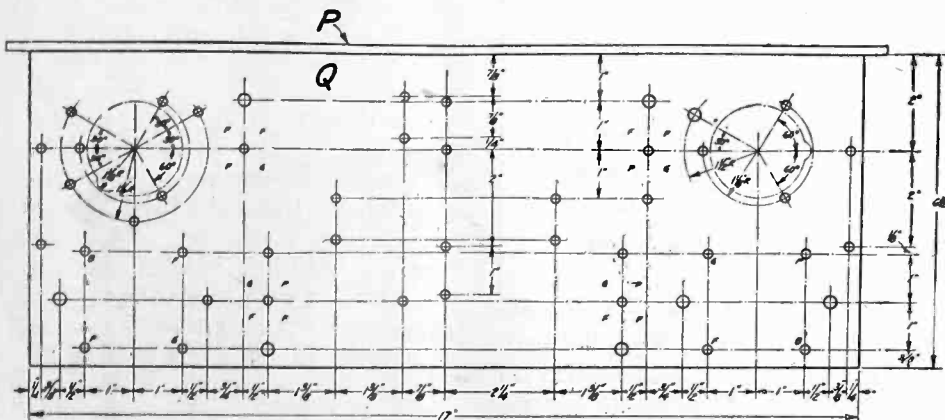

Fig. 3. Sub-panel Layout.

panel as shown in the pictures and diagrams. The three fixed condensers, *G*, *H* and *I* are next mounted on the lower side, then the four tube sockets, R_1 , R_2 , R_3 and R_4 , and the audio transformers *C* and *D* on the upper side.

The two condensers *E* and *F* are

radiohm *O* and the condenser dial are mounted on the front panel, after which the sub-panel is fastened to it by means of the brackets provided for this purpose. All knobs and the dial should be adjusted for proper positions.

The wiring connections are self-evi-

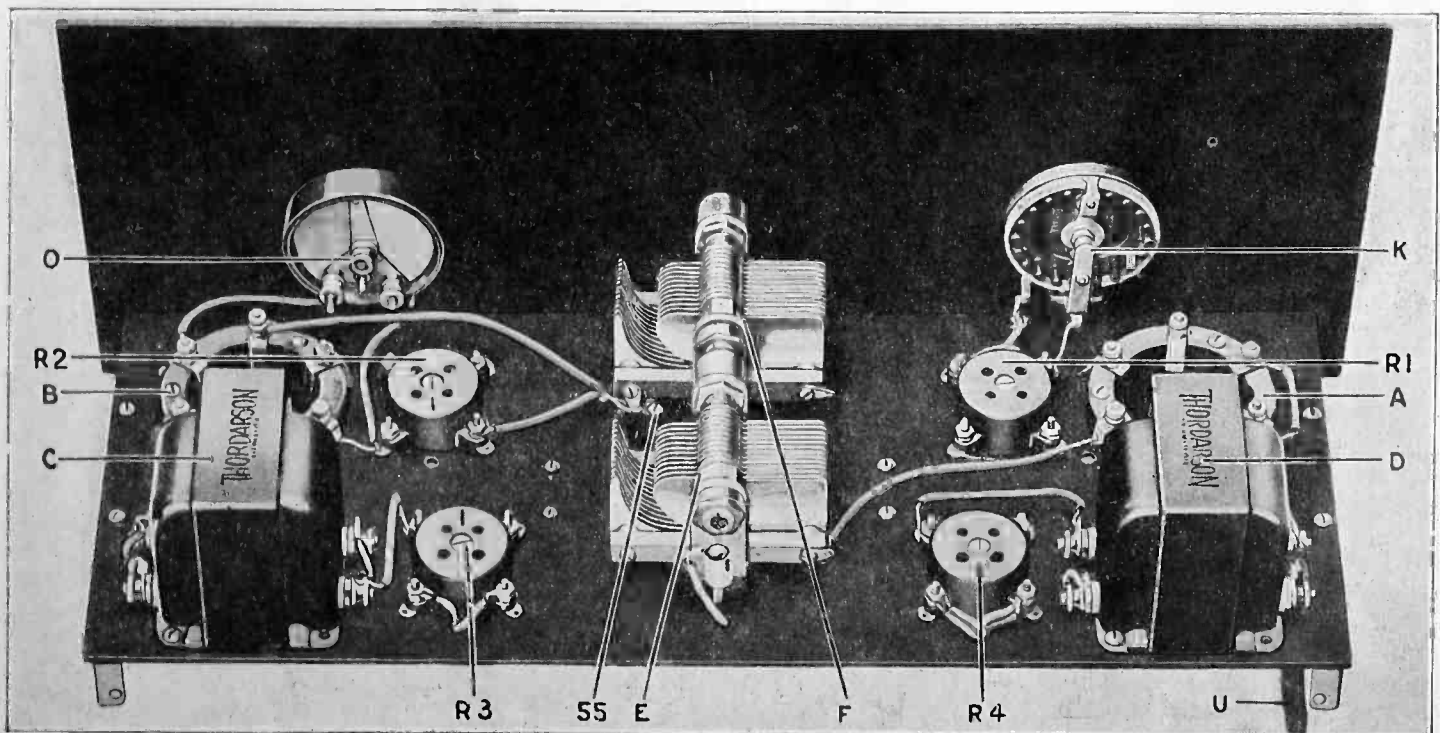

Rear View Showing Top of Sub-Panel.

may be regulated by adjusting with the finger the rotor of coil *A*. When its axis is at right angles to that of the outside tube, selectivity will be greatest. Once set, this adjustment may be ignored.

In order to hear distant stations, the volume control must be turned to the right all the way. Then, if the selector is rotated, squeals will be heard if stations are operating. If no squeals are heard, the rotor of coil *B* must be adjusted with the finger. Generally, if the rotor and stator axes coincide the receiver will oscillate, with consequent squeals when stations are tuned in. This squealing may be stopped by retarding the volume knob to the point where a squeal just ceases and the intelligible signal is heard. This is the most sensitive position of the volume knob, and will vary slightly for different settings of the selector.

If, on some fairly weak station, say one just giving good loud-speaker volume, two points are noticed on the selector dial at which the station may be heard, separated by about a degree or two, this condition may be remedied by adjusting *N* in small steps, which will cause the two points to merge. Should it by any chance cause the points to separate, then the ganging of condensers *E* and *F* must be altered. This is done by causing *F* to lag behind *E*. The adjustment is made by relocking the shafts by means of the set screws in *F* so that when the rotor and stator plate edges of *E* (rear) are in line on the left side, the rotor plates edges of *F* are about one-eighth in. below the stator plate edges at the left outside edge of the plate sections. Readjusting *N* will, under this new condition, cause the two points at which a station is heard to merge, rather than separate. At worst, however, this is a trouble seldom encountered in practice.

PARTS USED	
P-1	Bakelite front panel, 7x18x 1/4 in.
Q-1	Bakelite sub-panel, 6 1/2 x 17 x 1/4 in.
U-1	Belden S-C wiring harness complete with all leads.
C-D-2	Thordarson power transformers, No. 200R.
E-F-2	Silver-Marshall .00035 SLF condensers, No. 310.
A-B-1	each Silver Marshall 110A and 114A coils (100-550 meters).
A-B-2	Sockets for above coils, No. 515.
O-1	Centralab Radlohm, 25,000 ohm, No. 25 M. S. R.
R1, R2,	
R3, R4-4	Silver-Marshall UX tube sockets, No. 510.
E-F-1	Silver-Marshall vernier dial, No. 801.
N-1	Silver-Marshall compensating condenser, No. 340-000025.
S1, S2-1	Pair Silver-Marshall mounting brackets, No. 540.
K-1	Yaxley 6 ohm rheostat, No. 16K.
M1-1	Yaxley 2-spring jack, No. 2.
M2-1	Yaxley 1-spring jack, No. 1.
L-1	Yaxley battery switch, No. 10.
J-1	Polymet 2 megohm grid leak.
I-1	Polymet .00015 mica condenser with leak clips.
G-1	Polymet .002 mica condenser.
H-1	Polymet .005 mica condenser.
12	3/4 in. 6/32 Roundhead Brass Screws.
8	1/2 in. 6/32 Roundhead Brass Screws.
4	1 in. 6/32 Flat Head Brass Screws.
24	6/32 Brass Nuts.

The quality of the receiver fully justifies the use of a cone loud-speaker in order to take full advantage of the excellent reproduction of which the system is capable.

The wavelength range of the set depends upon the length of the plug-in inductances used. Two standard "A" types cover from 190 to 550 meters; two "B" type from 90 to 210 meters; two "C" type from 50 to 110 meters; and a set of "D" or "E" coils allow foreign stations up to 1800 meters to be heard.

THE WONDERFUL BATTYOMETER

(Continued from Page 24)

And during the long watches of the night, indeed doth our little ham follow in the footsteps of his ancestors, and of those who had gone before him. He polisheth up the trusty key, and wipeth the dust from the condensers. He drieth the tears from the countenance of the first engineer and telleth him why his one-tube blooper at home will not bloop. He handleth traffic promptly and press he copyeth copiously, if not, perhaps, accurately. He complaineth not, neither doth he grumble, but endureth cheerfully all hardships, and maketh himself well liked by all.

Now it came to pass that in the fourth watch of the night, there cometh great confusion on board the vessel, and the cry of "fire!" And the captain cometh into the radio room and saith unto the operator, "Send thou quickly an SOS, for we burn." And the operator doeth even so, and in the nick of time there cometh alongside another ship, and taketh off those from the burning one. The brave operator is called from his post, the same that is in the furthestmost parts of the ship. But as he fleeth, he beholdeth, clinging to the rail of the burning vessel, a beautiful maiden, such as his eyes hath not seen in all the years of his wanderings. And it cometh to pass that he pauseth in his flight, and throweth himself before the beautiful maiden, crying, "O, thou lovely one, wilt allow me to save thee?" And behold! she falleth on his neck and weepeth.

Then cometh the men from the rescue boat and carryeth them back to the land of their fathers. And there is much rejoicing in all the tents of the tribe of Ham, and a great marriage feast is prepared for this heroic son and his beautiful bride, whom he hath so miraculously rescued from a watery grave.

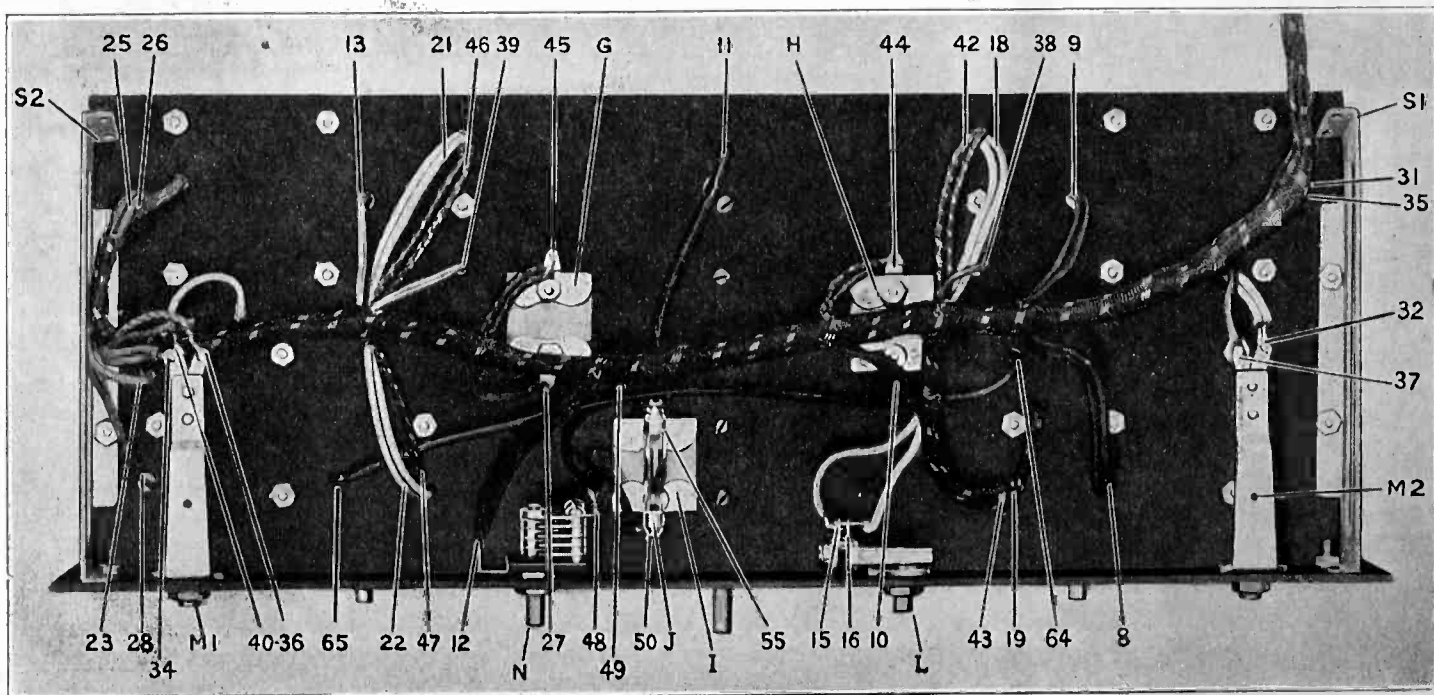

Bottom of Sub-Panel.

The Efficient Reception of Short Waves

Practical Hints Concerning the Reception of the Short Waves Efficiently

By Willis L. Nye

THE field of the short waves, that is, the wave bands that are in use below 200 meters today, presents a new field for the radiocast listener to dabble with, and the splendid results that are obtainable with simple equipment surely makes the investigation of this field very attractive. To get the fine results all one has to do is to apply his knowledge that he uses for longer wave work and, perhaps, apply a slight bit more of technique.

It is assumed that the radio listener has his receiver assembled, but that he has encountered some difficulty. It is the purpose of this article to help clear up the situation so that after applying the few suggestions here given that the radio fan will be able to accomplish something worth while in this new field and enjoy the new thrills that it affords.

Short wave receivers generally employ the standard circuits that are used for radiocast reception, namely, Hartley-Reinartz, Colpitts, "3" circuit, capacity feed-back, or tuned plate and grid circuits. It will be assumed that the receiver already in use falls in among the class mentioned. Each has its apparent and individual merits and all, if properly handled, tube for tube, will give about the same results as to selectivity and volume. One emphasis that is to be made is that a principle used for reception on 200 to 600 meters can just as well be applied down the waveband scale. Of course there will be variations, etc., made to suit the conditions that it applies to.

The secondary condenser is perhaps the most important piece of apparatus in the receiver and, more so, its arrangement in regards to the rest of the circuit. The standard way is to connect it directly across the grid and filament. However, a better way is to use it shunted across as shown in Fig. 6. This allows one to get a very low wavelength band and at the same time spreads the stations more out on the dials and helps eliminate the cramping so noticeable in the lower wave region, especially on voice transmission.

The capacity of the tuning condenser had best be not more than of 150 micro-microfarads or else the tuning will be cramped. As it is difficult to secure a low capacity as this in tuning condensers, the only method to resort to is to carefully "operate" on a condenser of large capacity and remove the unnecessary plates. This can be done if one is careful in doing this work without damaging the condenser to impair its electrical efficiency. About two rotary and three

stationary plates are just right for tuning purposes.

It would be wise to use one of the "straight frequency line" condensers and cut it down to what is required. Another way of securing a low tuning capacity is to place in series with an ordinary 11 plate condenser, a fixed capacity of 250 micro-microfarads. This will materially reduce the minimum capacity but it will decrease the signal strength a bit. However, it is very efficient nevertheless. This can be done easily if a condenser larger than recommended is already in place. It can be cut when one desires to change the wavelength range.

By making taps on the coil as given in Fig. 1, one may cover a larger band without as much cramping of the tuning if he used this method instead of the usual way of connecting the tuning condenser.

The feedback is another item that requires attention because proper control of it is essential. The Hartley-Reinartz uses parallel feed-back. It requires a choke as shown inserted in Fig. 7. The choke had better just be large enough to perform its best function and not larger. It would be advisable to try several chokes. Start in with one of 50 turns and increase the number up to

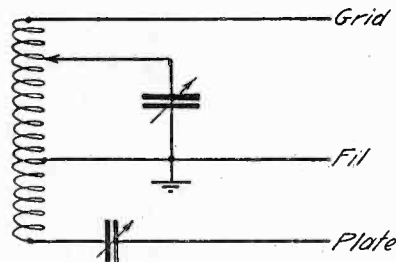

FIG. 1
Hartley-Reinartz

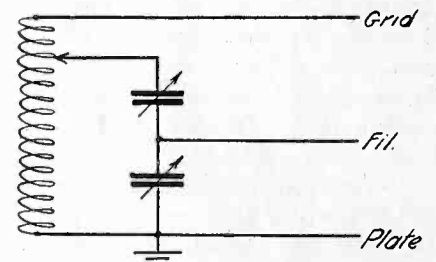

FIG. 2
Colpitts System

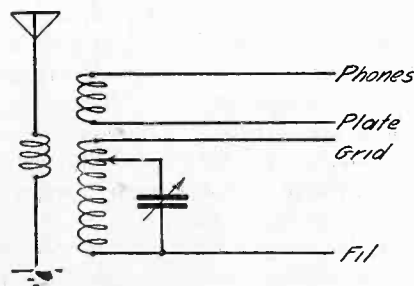

FIG. 3
Standard "3" Circuit

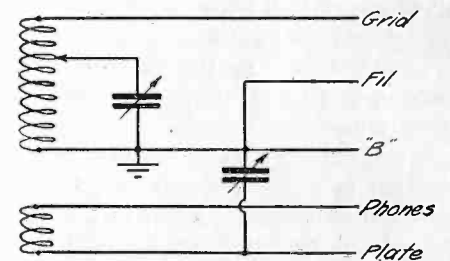

FIG. 4
Capacity Controlled Feedback

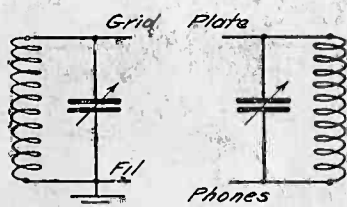

FIG. 5
Tuned Plate and Grid

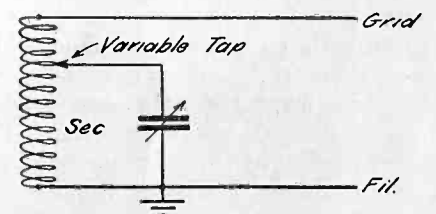

FIG. 6
Secondary Condenser Control

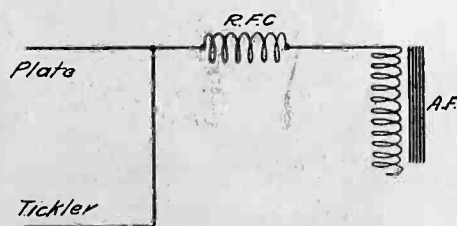

FIG. 7
Position of Choke Coil

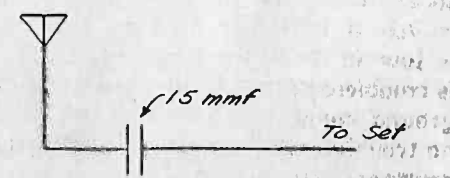

FIG. 8
Antenna Condenser

250. The chokes are easily made and it is well worth the while to try the different types of chokes. They may be wound on a dry wood dowel or 1 in. bakelite tubing.

The Colpitts circuit provides parallel feed-back control. It is a constant oscillator and is controlled in a good measure by a good filament rheostat. It also requires a choke.

The tuned plate and grid circuit feeds back through the internal capacity of the tube. It requires a very small choke and a by-pass condenser of high capacity (2000 micro-micro farads).

The method of controlling the feed-back by a variable throttling (by-pass) condenser is very popular. It is not critical perhaps as the previous methods given and does away with the necessity of a moving tickler coil.

The old standard three circuit regenerative circuit is commonly used in the short wave region and it has given very fine results. Careful design of the tickler coil is necessary and to get proper control the tickler coil should be very small and used at the filament end of the secondary. It does not require any choke but should be amply provided with the necessary by-pass condensers.

The antenna that is used for short wave reception should not be as large as the usual radiocast type and it should not be more than 60 feet long. A single wire is very suitable here for such needs. The antenna lead-in should be free from all obstructions. No. 12 enameled wire is probably the best kind of antenna wire to use for this purpose. Corrosion of the antenna will cut down the volume of short waves appreciably.

The antenna should be coupled to the receiver by a small condenser, say of 12 micro-microfarads. This, of course, should be adjusted until results commensurate with strength of the signals is obtained. In all cases the antenna coupling should be loose in respect to the secondary coil. Of course we can use the usual primary stunt but the antenna condenser scheme works very nicely in this region, so why not use it? If a primary coil is used it had best be about 3 in. away from the secondary so proper oscillations can be secured. The close proximity of the antenna will stop the receiver from oscillating. The coupling capacity scheme will vary with different antennas in regards to the condenser's capacity.

After all the foregoing points are looked over in the receiving set it is well to determine that the ground connection is low in resistance. Many times this is troublesome to the average fan. If the ground connection is in good condition no trouble will occur but if it is a "high" resistance ground, remedy it so that it is good electrically and probably your signal strength will be greater. Sometimes it is an advantage where no

(Continued on Page 61)

COMPARISON OF INDUCTANCE COILS

A coil to be used in the tuned circuits of a radiocast receiver should have the lowest possible resistance and apparent inductance from 500 to 1500 kilocycles as is consistent with a convenient size and shape of the coil. The radio frequency resistance, which is always greater than the direct current resistance, should not be unreasonably large in comparison. Any abnormal increase in apparent inductance at high frequencies is largely due to distributed capacity in the coil.

But the real criterion in the performance of the coil is a high value of the ratio of inductance to the resistance at high frequencies as compared to its value at low frequencies. This was explained by G. F. Lampkin in December, 1925, RADIO.

With these several points as a basis of comparison August Hund and H. B. de Groot of the U. S. Bureau of Standards have recently tested the performance of the various types of "low-loss" coils illustrated herewith. All the coils were designed to have an inductance of 291 microhenries at 1000 cycles, a good value for coils to be used in a radiocast receiver. Their complete findings are published in the bureau's Technologic Paper No. 298.

Their general conclusions were that loose-basket weave coil and the single-layer coil have the lowest radio frequency resistance, lowest apparent inductance, and the highest ratio of inductance to resistances over the range of radiocast frequencies. Other coils used in these comparative tests included radial basket-weave on cardboard and on hard rubber, narrow basket weave, and 2-, 3-, and 4-layer bank wound.

Studies were also made of the effects of different sizes of wire on these prop-

erties, these sizes including Nos. 28, 24 and 16 double cotton covered and Nos. 32-38 litz. The litz gave the highest ratio of inductance to resistance because of its much lower effective resistance. If solid wire is used it appears unnecessary to use larger than No. 24. It was found that as many as 6 of the 32 strands of No. 38 in the litz could be broken without seriously affecting the results.

The specifications of the single layer coil using the litz wire called for 65 turns of No. 32-38 d.s.c. litz wound on a hard rubber core 3.19 in. in diameter, the winding being 2.32 in. long. This coil had a direct current resistance of 1.25 ohms and an inductance to resistance ratio of 23.27 at 1000 cycles, of 90 at 300 kilocycles and of 45 at 1500 kilocycles. Using 55 turns of No. 28 wire on the same core, the winding being 1.24 in. long, the direct current resistance was 3.15 ohms and the ratio of inductance to resistance was 9.24 at 1000 cycles, 50 at 600 kilocycles and 25 at 1500 k.c.

The loose-basket weave coil of litz consisted of nine diagonal alternating windings of No. 32.38 d.s.c. on nine pairs of pins set in a circle 3.64 in. in

(Continued on Page 48)

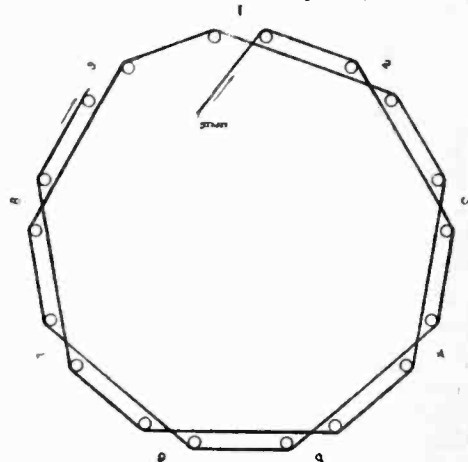

Method of Winding Loose Basket Weave.

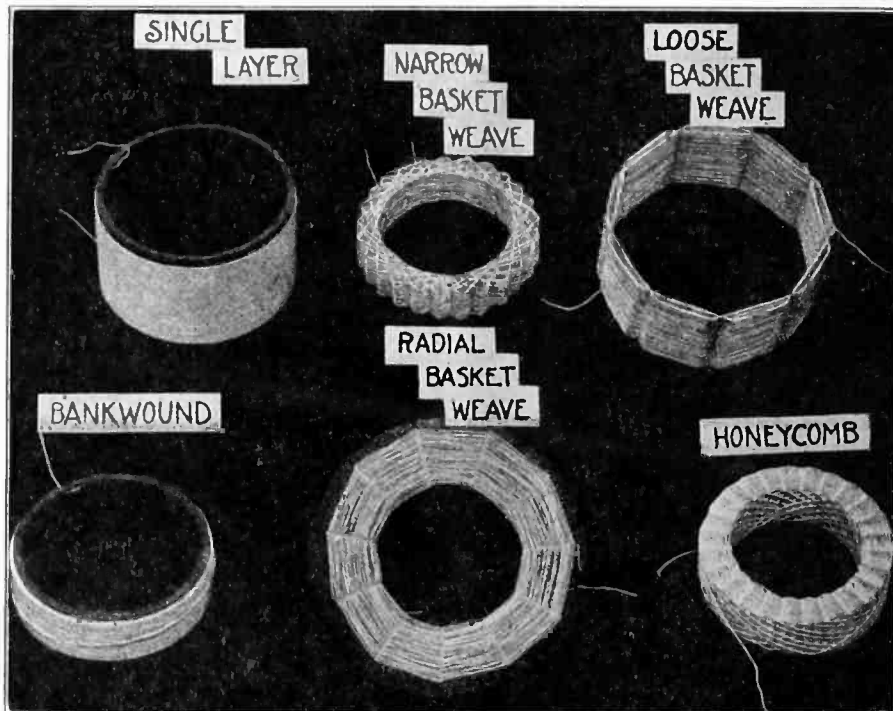

Low-Loss Coils Used for Measurements

Design of Low-Pass Filters

Theoretical Considerations and Their Practical Application to a Filter for Rectified 60-Cycle Alternating Current

By Jennings B. Dow

ELECTRICAL filters are necessary to smooth the pulsating output from a rectifier or generator if it is to be used as a satisfactory source of direct current for vacuum tube plate supply. This filtering process is equivalent to moving the shaded areas above

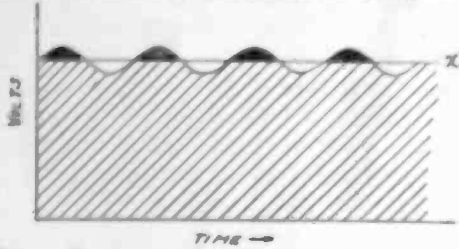

Fig. 1. Representation of Rectified Alternating Current.

the line X of Fig. 1 into the unshaded areas of the figure. This can be accomplished to a greater or less degree by a combination of inductance and capacity

to form a low-pass filter, the degree of filtration depending not only on the construction of the inductances and capacities but also upon the nature of the load to be fed through the filter. As the name implies, a low pass filter passes only low frequencies and stops high frequencies.

Fig. 2 shows six arrangements of low pass filters. The left hand circuit of Fig. 2-a is composed of two "T" sections while the right hand circuit consists of two "π" sections. In each circuit of Fig. 2-a, the sections have been divided by dotted lines for purposes of indicating "T" and "π" classification. It is obvious that the two center inductances, $L_1/2$, of the left circuit can be combined into one inductance having a value of L_1 without changing the effect. Similarly in the right figure the two capaci-

ties, $C_2/2$, may be combined into one capacity of twice the value, or C_2 . The left hand circuits of Figs. 2-b and 2-c also consist of two "T" sections, while the right hand figures each consist of two "π" sections.

For our purpose there is little difference in the performance of a "T" and "π" section filter. There is, however, an advantage in selecting combinations of the circuits shown and this will be explained. Attenuation is a term which will be used here in connection with the ability of a filter to cause a decay of pulsating energy. Obviously we are interested in suppressing pulsations in the wave since our aim is to flatten the curve of Fig. 1 into a straight horizontal line. We will also use the term *cut-off frequency* to define that frequency at which the filter begins to operate or suppress the wave. By way of further explanation of this point, it may be said that if a low pass filter is designed for a cut-off frequency of 60, it is meant that all frequencies above 60 will be attenuated. Those below it will be passed without attenuation. Every filter has a point of maximum attenuation which may or may not be close to the cut-off point. It is only through a consideration of the behavior of the circuits of Fig. 2 that the proper combination may be selected for a given purpose.

The circuits of Fig. 2-a have the following properties:

(1) The attenuation is such that maximum attenuation is obtained only at infinite values of frequency. Such filters are very effective in suppressing the high frequency constituents.

(2) A certain portion of the intermediate frequencies are passed and in order to suppress a bad disturbance having a frequency just above the cut-off frequency several "T" or "π" sections would have to be employed in series.

The circuits of Fig. 2-b have the following properties:

(1) The cut-off frequency is quite sharp.

(2) The attenuation effect rises rapidly from the cut-off frequency to the point of maximum attenuation, which may be placed at any desired frequency.

(3) For frequencies higher than that corresponding to maximum attenuation, the attenuation effect falls off again, reaches a certain minimum value, and rises again to infinity at infinite frequency.

(4) Since these circuits can be de-

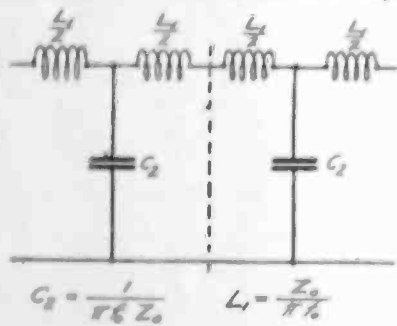

(a)

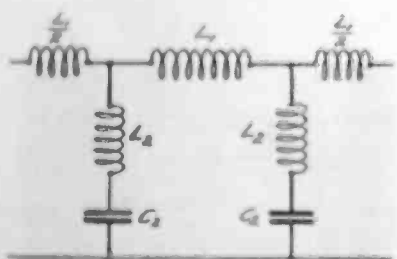
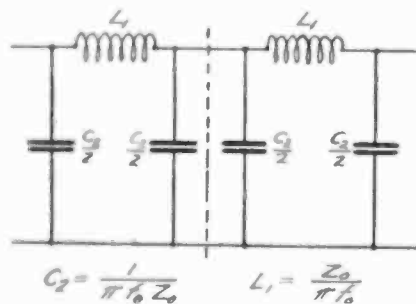

(b)

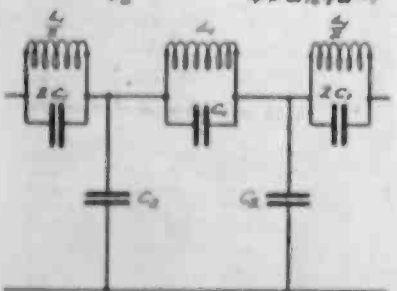
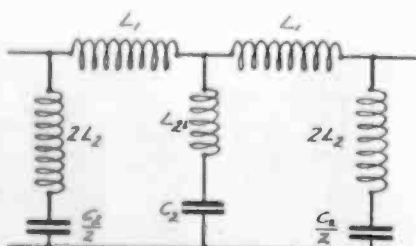

(c)

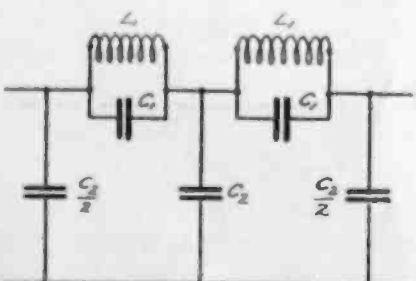

Fig. 2. Various Arrangements of Low-Pass Filters.

signed for a certain rather sharp cut-off and another definite frequency whose suppression is desired, they are frequently used.

(5) A disadvantage with the circuits of this figure lies in the use of the series resonant circuit across the line. At the resonant frequency, the impedance approaches zero, and as this circuit is across the line, disastrous results may follow, especially if the amplitude of the resonant wave is high.

The circuits of Fig. 2-c have the following properties:

- (1) Same as for Fig. 2-b.
- (2) Same as for Fig. 2-b.
- (3) For frequencies higher than that corresponding to maximum attenuation, the attenuation falls off again to some finite value at infinite frequency.
- (4) These circuits depend for their frequency of maximum attenuation upon the parallel resonant circuit in series with the line; hence the deficiencies of the circuits of Fig. 2-b are somewhat overcome.

A circuit consisting of a "π" section of Fig. 2-a together with a "π" section of 2-c is shown in Fig. 3. In this circuit the advantages of both the above mentioned circuits are obtained.

Let us now consider the details of design of these circuits in general and finally apply the ideas to a specific problem akin to the many which arise in connection with the use of filters in plate supply circuits. For the sake of conventionality, the following symbols will be used:

- f_o = cut-off frequency, or frequency at which the filter begins to operate.
- f_∞ = frequency of maximum attenuation.
- Z_o = impedance of the load being fed through the filter. For example,

if the load is the plate circuit of a 250 watt tube which is being fed from a 2000 volt generator and if the plate current is 250 milliamperes, the impedance of the load is

$$Z = \frac{E}{I} = \frac{2000}{0.25} = 8000 \text{ ohms.}$$

This is not the internal plate impedance of the tube.

L_1, L_2, C_1, C_2 = values of inductances and capacities which are to be determined. These values refer specifically to corresponding symbols in Fig. 2.

The formulas by which the various values of inductance and capacity can be found, are noted below each of the circuits of Fig. 2. The filter circuits shown consist of two sections each, and in adding or subtracting sections or in combining sections of other types, it is important to isolate the individual sections before combining the inductances and capacities at the junction ends of the sections. Fig. 3-a illustrates this point. In this filter, which consists of one "π" section of the type found in the right hand circuit of Fig. 2-a and a "π" section of the type found in Fig. 2-c, the two capacities, $C_2/2$ and $C_1^2/2$, are each in a separate section and their values must be determined independently. After this is done, a single capacity having a value equal to their sum may be substituted as shown at C_3 of Fig. 3-b.

The subject of filter design is not a difficult one providing it is attacked in the correct manner. Unless the inductances and capacities have the proper values for the task which the filter is to perform results will be highly unsatisfactory in most cases. On the other hand, proper choice of these constants will result in almost perfect filtering with two sections. More, of course, may

be added with correspondingly better results. Two sections are ample, however, for purposes with which we are concerned here.

To determine the effectiveness of a filter, a test circuit of the type shown in Fig. 4 may be used. It should be

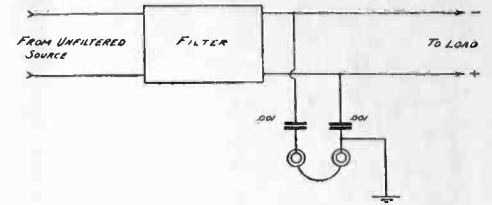

Fig. 4. Test Circuit for Determining Effectiveness of Filter.

unnecessary to state here that the phones in this circuit should not be touched if the potentials across the line are over 200 volts.

Fig. 5 shows two filter circuits.

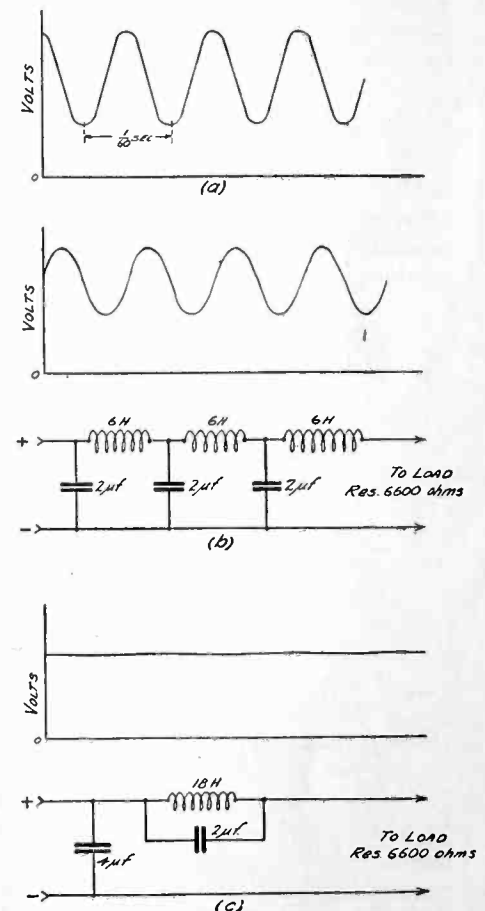

Fig. 5. Example of Improperly Designed Filters.

Each of these were connected to a rectifier having a common output wave form which it was desired to suppress. The curve of Fig. 5-a is that of the rectifier output characteristic. The curve above the circuit of 5-b which was traced by an oscilloscope shows the effect of that circuit wherein three 6-henry inductances and three 2-microfarad condensers were used. Fig. 5 shows a different arrangement of the same inductances and capacities, and the effect. Neither of these filters were properly designed and the data are shown here merely to illustrate that an arrangement of capacities and inductances does not necessarily constitute a filter.

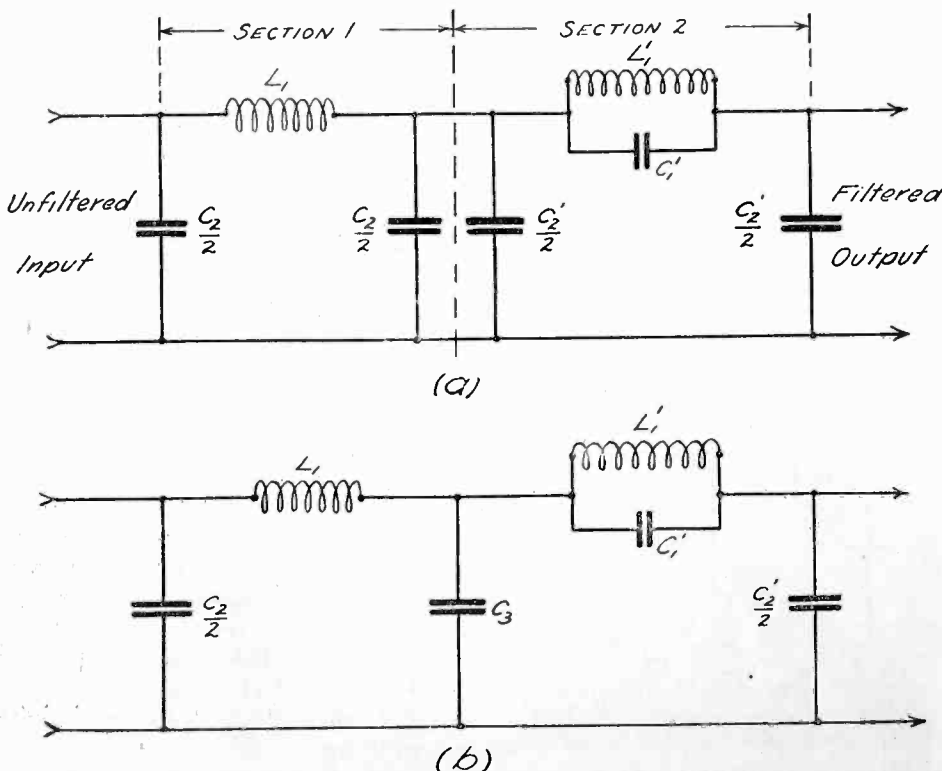

Fig. 3. Filter Circuit Whose Constants are Calculated in This Article.

Let us now turn our attention to the design of a composite filter of the type shown in Fig. 3-a. Both sections are of the "π" type. It was previously explained in connection with filter performance that the attenuating value of section 1 increases as the frequency increases and is infinite for infinite frequency. That of section 2 increases rapidly from the cut off frequency to the frequency of maximum attenuation, then falls off again to some finite value at an infinite frequency. A combination of the two sections yields great attenuation over all frequencies and the cut off is quite sharp. This point could be further sharpened by the addition of more sections like that of section 2 but we have no interest in such a refinement here since our primary interest lies in eliminating all frequencies within the limitations of practicability.

Let us assume that we have a pair of kenotron rectifier tubes connected in the conventional manner as illustrated in

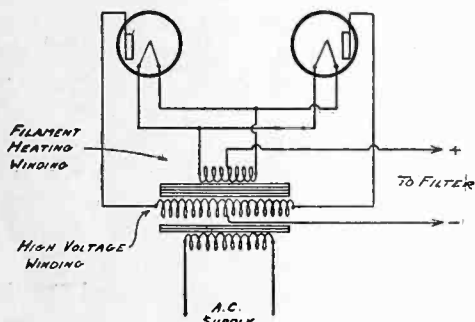

Fig. 6. Two-Tube Rectifier.

Fig. 6 and it is desired to rectify the output by means of the circuit shown in Fig. 3. The rectified output is to be used to supply two 50-watt tubes (UV 203) and the transmitter is to be used for C.W. signalling. Such a rectifier circuit as that of Fig. 6 gives an output wave having a frequency of twice the rectifier input frequency. Many attendant harmonics of this double frequency are usually present and these together with many transients must also be eliminated. The 120 cycle fundamental, due to rectifying 60 cycle current, is by far the most pronounced. The filter will therefore be designed to give maximum attenuation or the best filter effect on 120 cycles. Therefore $f_{\infty}=120$.

Because it would require very large values of inductance to locate the cut-off point below 40 cycles, and since at a 40 cycle cut-off point no difficulty will present itself in fixing the point of maximum attenuation at 120 cycles, we can conveniently make $f_0=40$.

Let us assume that the two 50 watt tubes in the transmitter are to be operated at normal input, i. e., $E_p=1000$ volts and $I_p=150$ milliamperes. By simple application of Ohms Law,

$$R = \frac{E}{I} = \frac{1000}{0.15} = 6666 \text{ ohms.}$$

Two tubes are being used in parallel,

therefore the net resistance is one-half of the above amount or 3333 ohms. This is for all practical purposes equivalent to the load impedance since we are concerned with steady direct current. $Z_0=3333$ ohms.

The solution of the problem now lies in dropping the above values of f_{∞} , f_0 , and Z_0 into the formulas found in Fig. 2, below the sections corresponding to those of Fig. 3-a.

For the first section of Fig. 3-a, we have

$$C_2 = \frac{1}{\pi f_0 Z_0} = \frac{1}{3.14 \times 40 \times 3333} = 0.00000239 \text{ farad}$$

or

$$C_2 = 2.39 \text{ microfarads.}$$

A difficulty presents itself here in that a capacity of 2.39 microfarads is one not readily obtainable. Let us take the nearest value to this that can be readily obtained from the market, i. e., 2 microfarads, and determine for what value of cut-off frequency such a capacity can be used. From equation (1), above,

$$f_0 = \frac{1}{\pi C_2 Z_0} = \frac{1}{3.14 \times 0.000002 \times 3333} = 48 \text{ cycles.}$$

It is a matter of using a non-standard value of capacity for C_2 , or of raising the cut-off frequency to 48 cycles. The latter course will be satisfactory here since no pronounced disturbance should be present between 40 and 48 cycles.

Now, using $f_0=48$ cycles, compute the value of inductance required by similar reference to the formula for L_1 under Fig. 2-a.

$$L_1 = \frac{Z_0}{\pi f_0} = \frac{3333}{3.14 \times 48} = 22.1 \text{ henries.}$$

For section 1 of our filter, then, we require an inductance, $L_1=22.1$ henries and two condensers each having a value of $C_2/2$ or 1 microfarad.

Section 2 is of the type shown in the right hand figure of 2-c. By reference to the formula under this figure,

$$a = \frac{f_{\infty}}{f_0} = \frac{120}{40} = 3$$

$$C_2^1 = \frac{\sqrt{a^2 - 1}}{\pi a f_0 Z_0} = \frac{2.83}{3.14 \times 3 \times 40 \times 3333} = 0.00000225 \text{ farad.}$$

or, $C_2^1=2.25$ microfarads.

Again we have a value of capacity that is not readily obtainable and it will be best to adopt the nearest marketed value which is two microfarads. With this value determine if the cut-off frequency corresponding to the use of the new capacity will be satisfactory. Since the value of factor "a" is also dependent upon the new unknown cut-off frequency, it is not possible to determine the new cut-off frequency from equation (5) alone. However, since, $a=f_{\infty}/f_0$

we can substitute this value into equation (5) and then solve for f_0 . Substituting

$$C_2^1 = \frac{\sqrt{(f_{\infty}/f_0)^2 - 1}}{\pi (f_{\infty}/f_0) f_0 Z_0}$$

Squaring both sides of the equation and solving for f_0 ,

(6)

$$f_0 = \frac{f_{\infty}}{\sqrt{C_2^1{}^2 \pi^2 f_{\infty}^2 Z_0^2 + 1}}$$

Substituting the value of $C_2^1=2$ microfarads, or 0.000002 farad and using previous values of f_{∞} and Z_0 ,

$$f_0 = \frac{120}{\sqrt{0.000002^2 \times 3.14^2 \times 120^2 \times 3333^2 + 1}} = 43.2$$

This value of cut-off frequency is sufficiently close to the original value of 40 that we may consider it entirely satisfactory, and it permits of using a standard easily obtained value of capacity. Using $f_0=43.2$,

$$a = \frac{120}{43.2} = 2.78$$

We now have the necessary data for solving for C_1^1 . From Fig. 2-c,

(7)

$$C_1^1 = \frac{1}{4 a f_0 Z_0 \sqrt{a^2 - 1}}$$

$$C_1^1 = \frac{1}{4 \times 2.78 \times 43.2 \times 3333 \times 2.6}$$

$$C_1^1 = 0.00000024 \text{ farads} = 0.24 \text{ microfarad.}$$

A 0.25 microfarad capacity will suffice here. Any value reasonably close to this can be used since the inductance L_1 can be made variable to the degree necessary for adjustment of the circuit, and the filtering action of the section as a whole will be only slightly affected.

We are now ready to compute the value of the inductance required at L_1^1 . By reference to Fig. 2-c,

(8)

$$L_1^1 = \frac{Z_0 \sqrt{a^2 - 1}}{\pi a f_0} = \frac{3333 \times 2.6}{3.14 \times 2.78 \times 43.2} = 23 \text{ henries.}$$

For section 2, then, we require two condensers each having a value of $C_2^1/2$ or one microfarad; one capacity having a value of $C_1^1=0.25$ microfarad and an inductance of $L_1^1=23$ henries.

As shown in Fig. 3-b, the capacity $C_2/2$ of the first section of the filter and the capacity $C_2^1/2$ of the second section may be combined into a single capacity equal in value to their sum or to 2 microfarads.

Filter circuits designed in accordance with the methods outlined above will give almost complete filtering above the cut-off frequency, and the resulting filters are the best that can be made without going to the extreme in combining a large number of sections. Such filters are particularly well adapted to C. W. transmitters and radiophones in which grid modulation is employed.

(Continued on Page 62)

RADIO STATION KFWI

By DAVID GIBBONS

THE conventional station has been described and pictured so often in the past two or three years that it has lost its appeal to the average reader, who promptly recognizes the photographs, and diagrams, and passes on to something more exciting—the letters to the editor, for instance. San Francisco's newest station KFWI, recently put in operation by Radio Entertainments, Inc., embodies, however, some new ideas which may interest the reader, technical or otherwise.

In the first place, the studio and the transmitting station are about twelve

being in radiocasting as its sole business, and not as a sideline. Consequently the programs must be of such uniform excellence as to hold its audience permanently, because the various firms which give courtesy programs over this station would soon learn if they were "playing to an empty house," and there's hardly anything that will rile the modern business man more than to pay out a lot of good money for a somewhat intangible form of advertising, and discover later that the whole thing was a "dud."

The transmitting apparatus is a standard 500 watt Western Electric set, and it has built into it the latest type of harmonic suppressor which effectively prevents KFWI being heard on any

case, and it is so with radio stations. High power, costly equipment and an elaborate, expensive staff, is not always the means of reaching the interest and affection of the radio fans. In the short period that KFWI has been on the air it has won an enviable place in the good graces of the listening public, and this can only be attributed to the fact that the management of this station is animated by a sincere desire to be of real and permanent service to its rapidly growing audience.

THE BRITISH RADIO MANUFACTURERS AGAINST THE PRESENT FORM OF BRITISH BROADCASTING

The radio apparatus manufacturers and traders of the British Isles have recently presented to the government radio committee their objections to the present system of broadcasting. They show that with even the most expensive receivers it is impossible to obtain any alternative programs from the nearest broadcasting station, owing to the low power of the stations as a whole and also because of the interference.

As an alternative scheme they suggested that the country should be divided up into six or seven zones and that each zone should possess a high-power station of some 25 kilowatts. These stations should be linked up to a central studio as well as to local studios. In this manner it was suggested that the owner of a moderately expensive set would be able to pick up all the stations and so obtain alternative programs after the fashion that prevails in America, and the crystal receiver would be able to intercept at least two of the stations.

The manufacturers further advocated the erection of a super power station for international work as well as ordinary long distance broadcasting, as they regarded the international aspect as very important especially in the establishment of world understanding.

It was shown that the earnings of the manufacturers had increased from £10,000,000 to £12,500,000 in a year, but it was undoubtedly in their minds that this increase could be largely augmented if the system was improved along the lines suggested although this latter point was not mentioned at the committee.

During the proceedings it was prominently brought to the committee's notice that it was not the manufacturers' desire for the control of broadcasting to fall into the hands of the government.

The base may be easily removed from a vacuum tube by first taking out the four prongs and then filling the resultant cavities with alcohol. If this be allowed to stand for about 15 minutes the glass shell may be gently twisted and separated from the base intact.



Radio Station KFWI

miles apart. The studio is located on Kearny Street in the heart of the business district of San Francisco, and the station is at South San Francisco on the shores of San Francisco Bay. This latter location was selected after extensive tests, as being an ideal spot for radio transmission, and the results obtained so far have certainly fully justified the selection.

Adjoining the studio on Kearny Street are the offices of the company, and it would surely surprise some of the pessimists who, a few years ago, predicted that radio was just a passing fad, to visit this up-to-date, spacious office which looks more like the home of a prosperous real estate or insurance concern.

Besides affording a perfect spot for transmission, the placing of the station in its present location, also achieves another highly desirable result. It eliminates the possibility of causing interference in the already congested ether by the erection of another 500 watt station within the city limits. This consideration of the interests of the public has naturally produced quite a favorable reaction with a corresponding increase in the goodwill, which after all is the chief stock-in-trade of all radiocast stations.

KFWI is not connected with any store, newspaper, or other institution,

other than its assigned wavelength. The station building also contains the motor-generator room, and the living quarters of the operator in charge. It is located on San Bruno Point at South San Francisco, quite close to the government naval station. The latter was originally built by the Federal Telegraph Co., and used by the navy during the war and since. It is now used for reception only.

The towers of KFWI are 100 ft. high and 115 ft. apart.

The ground system consists of ten lengths of aerial wire, and five lengths of 1 in. copper ribbon buried in a trench 4 ft. deep, and about 50 ft. long, almost directly under the aerial. These wires and ribbon are all soldered together at both ends, and at the end furthest away from the set, there is also attached a copper ground-cone filled with coke. This latter retains moisture for a long period, and insures a reliable ground at all times, regardless of surface conditions.

Every owner of a radio receiver knows quite well that broadcasting stations have a personality just as distinct, but just as elusive and difficult to describe, as have individuals. A rich man or a powerful man does not always have the most pleasing personality. In fact more often than not the reverse is the



QUERIES and REPLIES



Questions of general interest are published in this department. Questions should be brief, typewritten, or in ink, written on one side of the paper, and should state whether the answer is to be published or personally acknowledged. Where personal answer is desired, a fee of 25c per question, including diagrams, should be sent. If questions require special work, or diagrams, particularly those of factory-built receivers, an extra charge will be made, and correspondents will be notified of the amount of this charge before answer is made.

How can I eliminate the tendency of a 5-tube tuned r.f. set to oscillate? Volume is not strong enough on 90 volts "B" battery. How may it be increased? Unable to get wavelengths below 260 meters. Can this trouble be cured?—B.J.G., Lafayette, Ind.

If the set is of the neutralized type, it may need re-neutralization. If of the non-neutralized type, the trouble may be located in defective B battery cells, low emission tubes, or worn out C batteries. The volume may be increased by replacing the last audio tube with a UX-CX-112 power tube, and increasing the B battery to 150 volts and the C battery to 10½ volts. If the set does not tune below 250 meters, the secondaries of the r.f. transformers have too many turns, or the minimum capacity of the variable condensers shunted across these coils is too high. Try removing 5 turns at a time from the filament end of the secondary coils, and observe what happens to the maximum and minimum wavelength range of the set. Fixed condensers of .00005 mfd. maximum, placed in series with the variable condensers, will lower the minimum wavelength of the set a few meters, but these condensers will have to be cut out of the circuit when waves above 250 meters are desired.

Please describe the circuit of the new Crosley 4-29 Receiver which has been recently announced. Will it operate a loud speaker on distant stations?—W.H.H., Altoona, Pa.

The circuit diagram of the Crosley 4-29 is shown in Fig. 1. It is a four-tube regenerative receiver, incorporating a radio frequency stage ahead of the regenerative de-

Due to the unprecedented number of questions received, there will be an unavoidable delay in personal answers to questions requiring diagrams. Questions unaccompanied by the usual fees cannot be answered by mail.

tector tube, to prevent radiation and increase the range. The receiver will undoubtedly bring in stations 500 miles or more distant, on the loud speaker, at night.

Would like to make a tube rejuvenator, but am unable to locate data for its construction. What material is required, and how should it be connected together?—R.F.L., Corona, Calif.

The circuit diagram for a home-made rejuvenator is shown in Fig. 2. You will re-

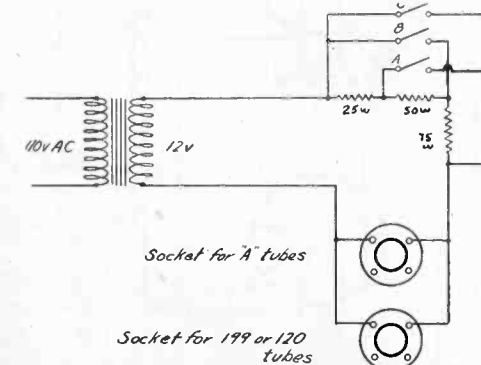

Fig. 2. Connections for Home-Made Tube Rejuvenator.

quire a 5 or 10 watt bell ringing transformer having a secondary of 12 volts, three

single pole single throw switches, two vacuum tube sockets and a set of fixed resistances. The type 199 tubes require 150 ohms in series with the filament to limit the current to 60 milliamperes when operated from the 12 volt secondary of the transformer. The type 120 power tubes need only 75 ohms in series with the filament, for 120 milliamperes filament current, and the A type tube requires 25 ohms to reduce the current to .25 amperes. A convenient method of making the resistances is to obtain one each of 25, 50 and 75 ohm size, and connect them in series. This gives a total of 150 ohms, and is right for the 99 tube. By cutting switch C into the circuit, the full 12 volts can be applied across the 199 tube filament, for the flashing process of 15 seconds. Opening switch C will reduce the current to normal, and the tube should be allowed to operate at this current for 45 minutes or more. For the 120 tube, close switch C again, flash the tube for 15 seconds, open switch C and close switch B, shorting out the 25 and 50 ohm resistances, but allowing the 75 ohm resistance to remain in the circuit, limiting the current to 120 milliamperes. For the A type tube, close switch C to flash the tube, open it again, and close switch A, shorting out the 50 and 75 ohm resistances, but keeping the 25 ohm resistance in the circuit.

The 25 ohm resistance may be obtained from a standard filament rheostat of that value. The 50 ohm resistance may be had from a 200 ohm potentiometer, a tap being taken off at approximately one-fourth of the total circumference of the wire bank. A tap at the opposite end of the potentiometer,

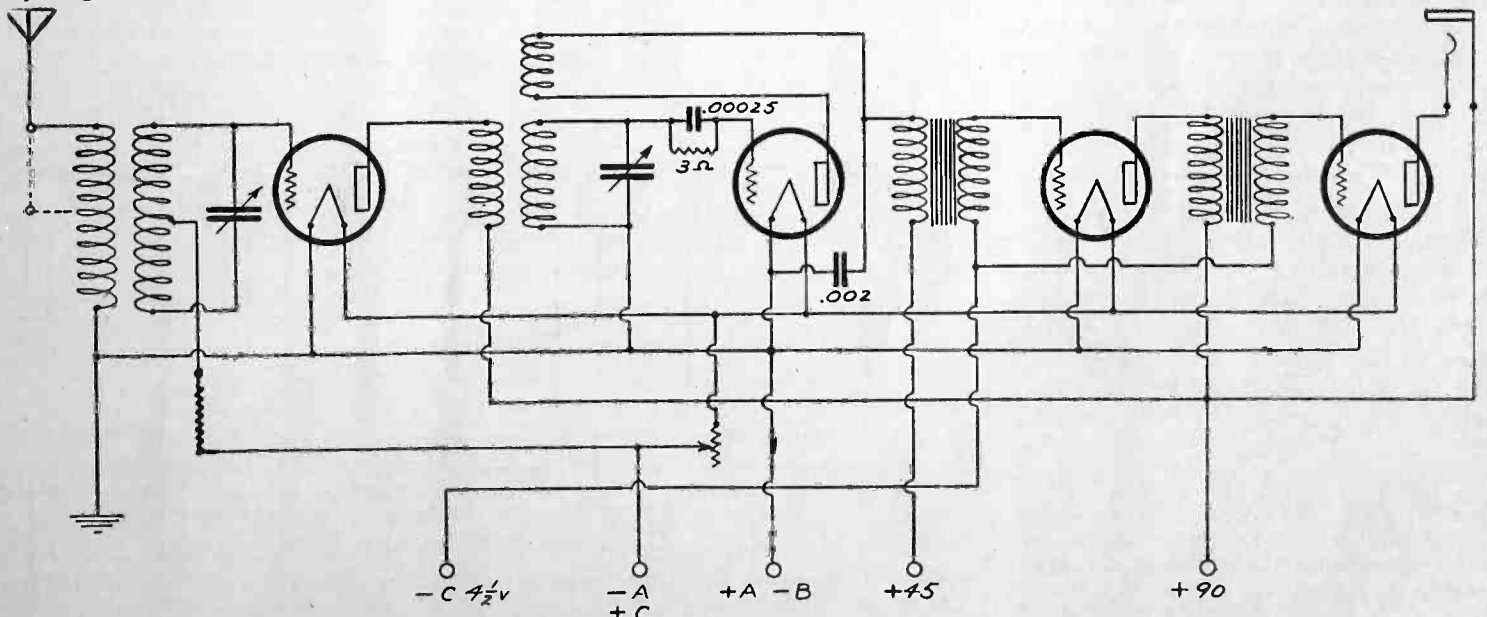

Fig. 1. Circuit of Crosley 4-29 Receiver.

three-eighths of the way from the terminal, will give a resistance of 75 ohms between the first tap and the second one taken off. This method will give values only approximately correct, but will be sufficient for all ordinary purposes.

Please give me data for making a trickle charger, for my 6-volt storage battery.—E.A.R., Whittier, Calif.

A simple electrolytic rectifier can be constructed, as has been described several times in these columns, but the diagram shown in Fig. 3 is given to show the proper connections. A bell-ringing transformer with 24 volt secondary is used to insulate the line from the battery circuit, and the Mazda lamp will limit the current to a small amount, depending upon the size of the lamp. The best procedure is to start out with a 10 watt lamp and measure the charging rate, increasing the size of the lamp until the right value of charging current is obtained. The plates in the rectifier should be formed

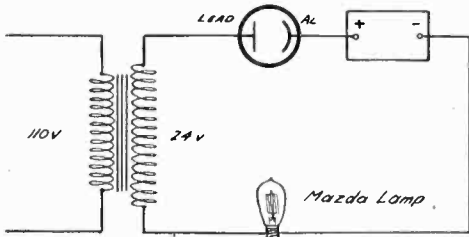

Fig. 3. Hookup of Trickle Charger.

before charging the battery, and is easiest done by connecting the rectifier directly across the transformer secondary for a few minutes. Only pure aluminum should be used for the aluminum electrode, and a concentrated solution of borax in distilled water is a good electrolyte. The lead plate may be 1x6 in. of 1/16 in. thickness, and the aluminum plate may be of the same size, of 1/32 in. material. A one-quart fruit jar is an excellent container for the electrolyte and electrodes.

Would like to see a diagram showing the circuit used in the Radiola 28. Would it be possible to substitute an antenna coupler for the loop in this set so that an outdoor antenna could be used?—R.A.L., Newport, Minn.

The circuit of the Radiola 28 is shown in Fig. 4. The set consists of one stage of tuned r.f. amplification, 1st detector, two stages of intermediate frequency amplification, 2nd detector and two stages of audio frequency amplification, with a dry cell power tube in the last audio stage. The circuit is similar to the Best superheterodyne described in May 1924 RADIO, and subse-

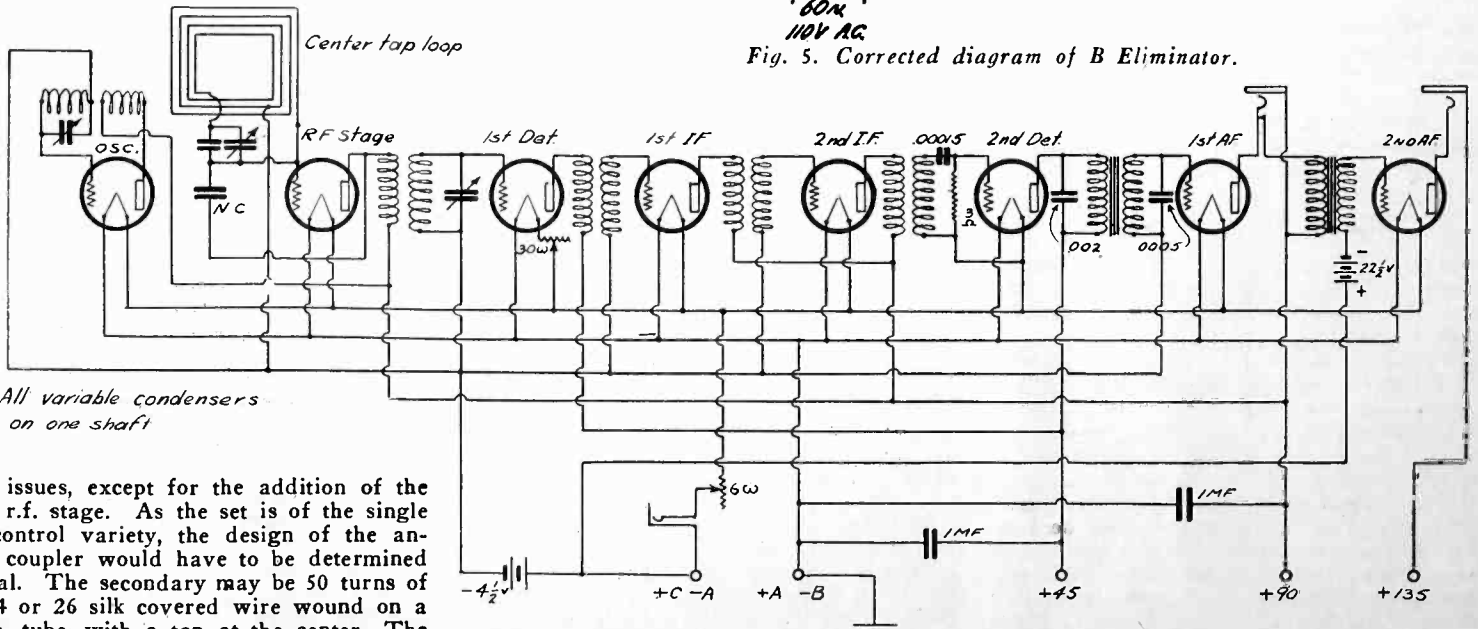

Fig. 4. Schematic Wiring Diagram of Radiola 28 Receiver.

minals in the set, the loop being disconnected. The antenna circuit should consist of .0005 mfd. variable condenser, 100 turn honeycomb coil for loading and the rotor of the variocoupler, which should have as few turns as is consistent with proper signal strength. The antenna tuner used in the 5 tube Best superheterodyne described in this issue will be satisfactory, although the secondary coil may not be exactly the right size. The final adjustment of the secondary should be made in tuning in a station. If the two knurled knobs on the panel of the Radiola 28 do not bring in any given station at approximately the same settings, then turns should be removed or added to the secondary to bring the settings to the same point.

Please publish a diagram for an 8 or 10-tube circuit which will bring in foreign stations.—L. K., Newark, O.

The circuit shown in Fig. 4 will be satisfactory. The tuned r.f. transformer should be of such design that it has a small external field, so that the popular toroid coils can be used with good results. The intermediate and tuned transformer may be of any standard make, and the same applies to the audio transformers. For constructional details, see the superheterodyne article in this issue. There is sufficient room on the panel and baseboard for 8 dry cell tubes, if an 8 tube set is desired.

I have an 8-tube E.I.S. Superheterodyne, and notice that when set is operating, I can touch or rub any piece of grounded metal in the room with a screw driver,

and make a loud scratching noise in the loud speaker. I also get a howling and scratching noise when using the antenna connection. What causes these phenomena?—E.C.G., Rochester, N. Y.

You are probably causing a change in body capacity to ground, and as the set is very sensitive, it picks up the clicks caused by minute discharges of static electricity through the screw-driver to ground. If the antenna connection is aperiodic, with untuned antenna circuit, a large amount of noise may be picked up, and it is advisable to tune the antenna, as described previously in these columns. If the set is unstable, when using the loop antenna, try grounding the negative A battery.

Correction: In Mr. E. E. Turner's article on "A New Five-Tube Receiver," in March 1926 RADIO, Fig. 2, the schematic wiring diagram on page 16, should show a connection between the plate circuits of the r. f. amplifier and 1st audio amplifier tubes and the plus 90 volt B supply. Furthermore the Raytheon tube is intended for B eliminator service only and is not rated above 60 milliamperes. A UX- or C-313 tube should be a satisfactory substitute in this circuit as it will readily deliver 70 milliamperes at the voltages specified.

Correction: In March RADIO, Page 21, Fig. 3, a diagram of the B battery eliminator described by Clinton Osborne is shown. This diagram has the rectifier leads reversed and a corrected diagram is shown in Fig. 5, with the rectifier properly connected.

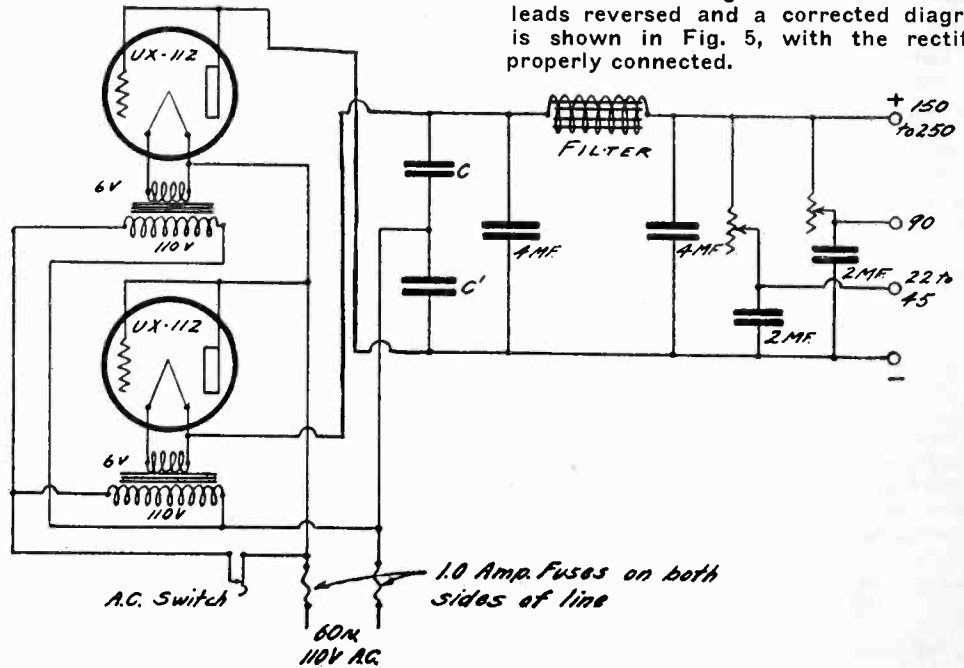
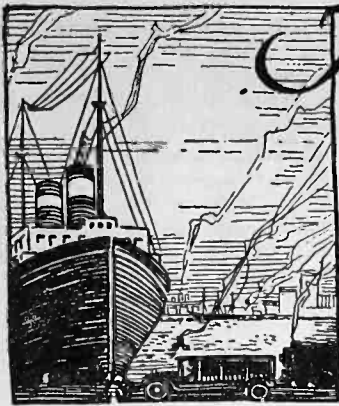

Fig. 5. Corrected diagram of B Eliminator.

quent issues, except for the addition of the tuned r.f. stage. As the set is of the single dial control variety, the design of the antenna coupler would have to be determined by trial. The secondary may be 50 turns of No. 24 or 26 silk covered wire wound on a 2 3/4 in. tube, with a tap at the center. The three leads from this coil go to the loop ter-



The COMMERCIAL BRASSPOUNDER

A Department for the Operator at Sea and Ashore



Edited by P. S. LUCAS

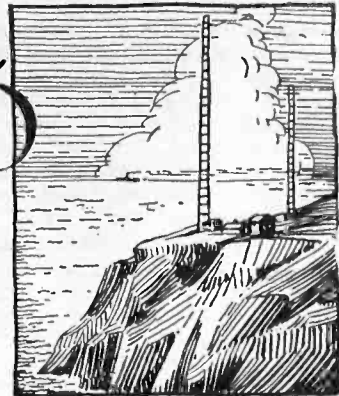

INTRODUCING THE COMMERCIAL BRASSPOUNDER

Last month, when the whole Western part of the country was quiet and broadcast fans were patiently listening for the East coast stations to prove themselves and to carry through to the West, Fate, unannounced, in the shape of a terrific storm at sea, stepped in and called a halt to the carefully planned tests. Thousands of disappointed listeners searched the air in vain. Some possibly blamed their receiving sets; others, the atmosphere, and some were probably disgusted with radio in general.

The next morning the papers gave out the true cause for the silence of the night before, telling of disasters at sea, of loss of lives, of heroic rescues. And no doubt many people began to see radio in a different light than before; to realize that perhaps concerts and tests and sermons were not quite the most important features of the science, after all; that the life of one humble engineer at sea is worth saving, even at the sacrifice of several hours of entertainment by many thousands of people.

The first use to which the science of radio was put was commercial and marine communication. And that field has developed, not with the overnight speed of the development of broadcasting, perhaps, but with regular, unflinching strides, until now it is an established and reliable means of communication.

Marine radio is more than insurance; it is a possible means of averting disaster. It is an aid to business, medical relief, a boon to pleasure. As an aid to navigation alone it stands out as being far more important than the field of radio which yields entertainment only.

Let us not forget, then, the radio man at sea, or in the land stations which connect us with the ships; and if this department seems to cater exclusively to the "commercial brasspounder," or "lightning-jerker," as the ship operator calls himself, don't feel that you have to hold a license to be a reader of, or a contributor to, these columns. We brasspounders want your friendship, and we shall be able to interest you with our yarns, just as surely as you "B.C.L.'s" and "Hams" will have something to tell us. If we talk in a dialect unknown to you, write and ask us to explain ourselves; or if there are phases of commercial radio you wish to understand more thoroughly, we shall try to describe them to you.

This department is practically an experiment as yet, and will only succeed if it becomes popular. Therefore, if you like it, it would help a lot to hear from you to that effect. We want to make the department a successful feature of RADIO for two reasons: first, because there is a lot of interesting material going to waste, and second, because we feel that the commercial operator should have a place to turn to for news of his fellow operators, pictures and write-ups of stations he has heard or worked, and a place in which he may write and tell his friends

of interesting stations, events or whatever strikes him as worth passing on. And the only way we can be successful is by gaining the cooperation of every reader.

Please, fellows, can't we count on you to fill these columns for us?

NORTH PACIFIC SCHEDULES

By L. O. DORAN

These schedules represent the work of the five years that Mr. Doran, who is now on the "West Jester" has been in the Oriental Feeder Service and on Struthers and Barry's Oriental run. The May installment will give the Japanese Weather Codes, Warnings given by Japanese Coast Stations, Indo-China Weather Reports, Translation tables for same, Ship Weather Reports to the Royal Observatory, Hong Kong, etc. Don't let them get by you, OM.

THE Berne "International List of Radio-telegraphic Stations" found in most ship radio rooms is somewhat lacking in precise information regarding Oriental radio stations, their schedules, etc. These notes contain data regarding weather reports, time signals, press schedules, etc., for the Oriental and North Pacific runs and are as complete and correct as possible up to date, July, 1925. Weather codes and other information is given, none of which has ever appeared in the Berne List or in any American publication. Some of the data from the Berne List has also been included to make the notes as complete as possible.

A list of time signals, weather and press broadcast schedules is given for the North Pacific, the Orient and India. Many of the stations send schedules on 600 meters and ships in the vicinity of these stations should make it a point to remain silent at the schedule times.

Static permitting, NPL San Diego morning press schedule can be copied on the North Pacific as far as the China coast. Japanese arc interference usually kills NPG San Francisco press several days to the eastward of Japan. NPO Cavite press can be easily copied anywhere on the Asiatic side of the world.

West of the Malay peninsula, POZ Nauen and other European press stations can easily be copied but their signal strength falls off considerably on the Pacific side of the peninsula.

Several pages of paid press are sent daily, except Sunday on the Naval trans-Pacific circuit; NPG to NPM to NPN to NPO. This press is not QST and should not be copied but for the benefit of those who wish to listen in on it the starting times of some of the schedules are given. The bulk of the files usually go through in the four or six hours immediately following the start of the schedule, being intercepted with government and other traffic.

The various weather codes used by the Japanese stations are given. JCS Choshi and JFRA Tokio generally send their warnings in English. JFRA sends first as listed on 4000 meters CW and repeats immediately afterwards on 600 meters CW.

Weather reports from VPS Cape d'Aguiar, Hong Kong, FFZ Zikawei, Shanghai and NPO Cavite are sent in plain language and all three give a general resume of Oriental

weather conditions, storm warnings, etc., followed by local weather forecasts. FFZ reports are sent first in French, then repeated in English and FFZ may use the Typhoon Warning Code given under Indo-China weather reports.

Indo-China weather and warning codes are given. India stations send weather for the Bay of Bengal or the Arabian Sea only, no local weather being sent.

NPO Cavite generally sends weather only after the evening time signal although typhoon warnings and traffic for ships may be sent after the morning time signal.

A great deal of valuable weather information can be obtained by intercepting the various ship reports sent in to the coast stations. All Japanese ships report three times daily at 6 a.m., noon and 6 p.m. ship's time. Ships in the China Sea report to VPS at 6 a.m. and 2 p.m. China Coast Time, and many report at the same time to FFZ and to NPO. Certain ships in the Bay of Bengal and the Arabian Sea report to India stations at 7 a.m. ship's time. The codes used in some of these ship reports are given hereafter.

The following Oriental stations carry on point-to-point work on the wave lengths given and DO NOT LISTEN on 600 meters while doing so. A lot of useless calling can be avoided by listening-in first on the alternative wave, provided the station is not already working on 600 meters.

VPS 2800 and HVH 1200.
FFZ answers and works on 800 meters only.

HVH and HVB 1200, HVA 2500.
VPW and VQF 1800.
Dutch East Indies Stations 1500 to 1900.
VPX 600 and VTV 1200.
VTR, VTP and VTV 1200.
VWC 2000 with inland stations.
VWM 2000 with inland stations.

Philippine Bureau of Posts stations work point-to-point on longer waves and listen for 600 meter calls for ONLY ten minutes of each hour that the station is open. Some of the ten-minute listening periods for the more important stations are given below. The complete list will be found on page 166 of the 9th Edition Berne List. In answering calls from ships, these stations generally use their longer wavelength.

KPI Cebu, 45' to 55' 7 a.m. to 8 p.m., 2800 meters; KPM Iloilo 00' to 10' 7 a.m. to 8 p.m., 2400 meters; KIW Zamboanga 00' to 10' 7 a.m. to 8 p.m., 1600 meters.

Ships bound for Yokohama should notify the Harbor Office station, call JFSA as to time of arrival. Ships bound for Shanghai notify the Shanghai pilot boat, call PTG. Ships bound for Calcutta notify the Sandheads pilot boat, call VWS.

All British coast stations in the Orient observe a silent period twice each hour from the 15th to 18th and from the 45th to 48th minutes and will not answer calls made at these times.

Shipping Board vessels should be on the lookout for broadcast traffic from NPO Cavite after the time signal and weather schedules. NPO sends the messages for several

days if no acknowledgment is received in the meantime.

Arc rush on 600 meters is very bad in the vicinity of Manila and it is almost impossible to raise NPO or KZRC or KZFR while the arcs at Cavite are running.

Two radiophone broadcasting stations are in operation at Manila, one at Shanghai and one at Tokio. All are low power affairs and have a very limited range because of the usual heavy static.

TIME CONVERSION TABLE

*GMT—0	1	2	3	4	5	6	7	8	9	10	11	
	12	13	14	15	16	17	18	19	20	21	22	23
*PST—16	17	18	19	20	21	22	23	0	1	2	3	
	4	5	6	7	8	9	10	11	12	13	14	15
*CCT—8	9	10	11	12	13	14	15	16	17	18	19	
	20	21	22	23	0	1	2	3	4	5	6	7

*GMT—Greenwich Mean Time.
 *PST—Pacific Standard Time. San Francisco Time.
 *CCT—China Coast Time. Standard time of Shanghai, Hong Kong, Manila.

Read columns vertically. Thus: Midnight GMT is equivalent to 4:00 P.M. PST and to 8:00 A.M. CCT.

SCHEDULES

NORTH PACIFIC, ORIENT, INDIA

Time C.M.T.	Call Wave Length	Station and What Sent
0000	NPL 9800	San Diego, Press to QST. Arc.
0000	XRT 600	Tsingtao, Weather code, Spk.
0010	JFRA 4000	Tokio, Code and English Weather, CW.
0030	JTJ 600	Kobe, Warnings, Spk.
0057	PKX 8800	Bandoeng Java, Time sigs, Arc.
0100	Ships 600	Weather code to India stations. Time approximate.
0155	BXY 2000	Hong Kong, Time sigs, CW.
0135	BZE 2000	Matara Ceylon, Weather, Spk.
0200	JJC 8500	Funabashi, Time sigs. Weather warnings, Arc.
0215	HVB 1200	Kien-an Indo-China, Time sigs, Weather, Spk.
0253	FFZ 800	Zikawei-Shanghai, Time sigs, Weather, Spk.
0255	NPO 5200	Cavite, Time sigs, Arc. Also on 2700 Spk.
0300	HVM 600	Myiho Indo-China, Weather, Spk.
0300	HVI 600	Tourane Indo-China, Weather, Spk.
0330	NPG 7000	San Francisco, Weather, Arc.
0350	HVH 1200	Fort Bayard, Weather to VPS on sched., Spk.
0400	J.ships* 600	Weather code to coast stations, Time approximate.
0457	VPB 600	Colombo, Time sigs, Spk.
0500	VPS 600	Hong Kong, Weather, Spk.
0500	NPO 8500	Cavite, Traffic and Press to Navy, Arc.
0518	VPS 2800	Hong Kong, Weather repeat, CW.
0530	NPR 2255	Dutch Harbor, Weather and repeat of NPG weather, Spk.
0555	NPC 4600	San Francisco, Time sigs, Arc.
0557	VPB 2000	Colombo, Time sigs, ICW.
0600	JFRA 4000	Tokio, Coded and English, Weather.
0600	Ships 600	Weather to VPS from China Sea.
0800	NPM 12180	Pearl Harbor, Traffic to NPN, Arc.
0800	NPN 9080	Guam, Traffic to NPO, Arc.
0825	VWC 2000	Calcutta, Time sigs, Weather, Spk.
0853	FFZ 800	Zikawei-Shanghai, Time sigs, Weather, Spk.
0900	VPS 600	Hong Kong, Weather, Spk.
0915	NPC 4600	San Francisco, Press to QST, Arc.
0918	VPS 2800	Hong Kong, Weather repeat, CW.
0930	HZA 20800	Saigon, Time sigs, Arc.
1000	NPL 9800	San Diego, Press to QST, Arc.
1000	J.ships* 600	Weather code to coast stations, Time approximate.
1000	XRT 600	Tsingtao, Weather code, Spk.
1110	JFRA 4000	Tokio, Weather warnings, Code and English, CW.
1159	JJC 4000	Funabashi, Time sigs. Weather warnings, Spk.
1159	JCS 600	Choshi, Time sigs. Weather warnings, Spk.
1200	VPS 600	Hong Kong, Weather, Spk.
1200	VPW 600	Singapore, Repeats VPS typhoon warnings if any out, Spk.
1218	VPS 2800	Hong Kong, Weather repeat, ICW.
1230	JTJ 600	Kobe, Weather warnings, Spk.
1230	JFK 600	Kurum Formosa, Warnings, Spk.
1255	BXY 2000	Hong Kong, Time sigs, ICW.
1300	JDA 600	Dairen, Warnings, Spk.
1300	JCX 600	Nawa, Warnings, ICW.
1320	HVI 600	Tourane, Indo-China, Weather, Spk.
1335	BZE 2000	Matara Ceylon, Weather, Spk.
1355	NPO 5200	Cavite, Time sigs, Weather, Arc. Also on 2700 Spk.
1400	HVM 600	Myiho Indo-China, Weather, Spk.
1400	FFZ 800	Zikawei-Shanghai, Weather, Spk.
1600	NPG 7240	San Francisco, Traffic to NPM, Arc.
1625	VWC 2000	Calcutta, Time sigs, Weather, Spk.
1657	VPB 600	Colombo, Time sigs, Spk.
1700	NPG 7000	San Francisco, Weather, Arc.
1730	NPR 2255	Dutch Harbor, Weather and repeat of NPG weather, Spk.
1757	VPB 2000	Colombo, Time sigs, CW.
1955	NPG 4600	San Francisco, Time sigs, Arc.
2000	NPM 12180	Pearl Harbor, Traffic to NPN, Arc.
2200	NPN 9080	Guam, Traffic to NPO, Arc.
2200	Ships 600	Weather to VPS from China Sea.
2200	J.ships* 600	Weather code to coast stations, Time approximate.
2230	NPM 2250	Pearl Harbor, Pacific Weather, CW.
2355	NPM 12180	Pearl Harbor, Time sigs, Arc.

*Jap ships.
 NOTE—The India ship weather reports and the Japanese ship weather reports are sent on ship's time which may be an hour or so fast or slow on the times given in the foregoing list.

"Q" SIGNALS

By R. O. KOCH, Chief W. M. M.

Much has been said about the much misused CQ in amateur work but very little about the unused Q signals in commercial work. Too many commercial men do not know how and when to use Q signals and much time could be saved and interference avoided if we all had them literally at our 'finger tips.' It doesn't mean anything to be able to write them out for the RI if you can't use them after you get on the job. To be sure, there are some Q signals on the list that are unnecessary and obsolete just like some of the ancient laws, but there are also some really good ones that are rarely, if ever, used. Whenever some operator does use a dusty one, there is always a pause until the receiving operator can dig up his list and find out what the other fellow is driving at. It is a part of our job to be able to use them fluently. Yet how many of us can?

Just a few days ago in heavy static I requested an operator to QSZ and he came right ahead with the message single. After a second request he came back and said, "I am using full power now." It is these kind of fellows that talk about being underpaid and never ask themselves whether or not they are worth the money they are getting.

Operators can help things a great deal if they will listen to their own fists and 'pick them to pieces' instead of listening only to the other fellow. Don't expect an operator to read anything that you couldn't yourself. It isn't reasonable to expect a man to grow up with you just for the sake of learning to know what you mean when you are not sending it.

Code butchering is not an art. A smooth steady fist is the one that gets the traffic off under any reasonable conditions and it is this kind of a fist that operators respect. Speed should be natural, not forced. Some men develop a miserable cement-mixing swing just to be different. It's the really good fist that's distinctive. In saying K (go ahead) don't think it is going to bring you fame to make it T E T, N T, T A or anything else. It's K, nothing else but. Now then OM, let's go! Use those Q signals and mix common sense with your brass pounding for real results.

GREAT LAKES REGS

By C. O. SLYFIELD

The regulations adopted for commercial traffic on the Great Lakes as a result of conferences of American and Canadian representatives at Detroit and Buffalo last year have eliminated all 600 meter signals from GP licensed ships on the Great Lakes and consequent interference to the B.C.L. The complete regulations are as follows:

All Canadian and American coast and ship stations on the Great Lakes open to General Public service business, must be equipped to work on a wavelength of 715 meters which will be the normal wavelength of the station. All Canadian and American stations must maintain a watch on this wavelength. A wavelength of 875 meters is authorized for the handling of General Public service correspondence. The use of this wavelength by coastal stations and vessels is optional.

Communication between a coastal station and a station on shipboard, or between ship stations shall be exchanged on the part of both by means of the same wavelength.

For General Public service communications between ship and shore and ship and ship, when working with stations other than the nearest station, must be on a wavelength of 875 meters or higher. Communication with a distant station will not be permitted if interference with the nearby station results.

All correspondence transmitted from a

ship or shore station will be in regular message form and copies of these communications must be placed on file.

The practice of transmitting notes under the prefix SVC or carrying on unofficial conversations, must be discontinued.

Service messages instead of being prefixed SVC or SCE as has been done in the past, must be prefixed "A" as the international regulations require. Particular stress was also laid on the abolition of unauthorized conversation in the form of service or dead-head messages.

WHO'S WHO AND WHERE

Alexander Kempfert, ex *Montebello*, is now second on the S.S. *Yale*, vice W. C. Chadwick. Chadwick took the *Calawaii* for the Hawaiian Islands. Keith Levy has also been assigned to the *Calawaii*, as chief.

Leo Shapiro and Ralph Johnson enjoyed a vacation on pay while the Union Oil tankers *Los Angeles* and *Warwick* were in for a blowdown.

Carl Zint of the *Sonoma* is now operating the broadcasting station at Big Bear. Quite a raise, Carl, in altitude, at least.

James Alverson, ex *La Brea* and *La Purissima*, has hooked up with the Radio Ore Co., assisting in research. Alverson went north to install an arc at Icy Bay, Alaska, last fall, and the water inundated the locality where the development was in progress, putting a stop to all work. Alverson, with his usual ingenuity, rigged up a small spark coil which he robbed off one of the gas engines, put up an antenna and established day and night communication over distances of 100 miles, which he kept up during the entire period they were marooned. The *Admiral Fiske*, on its way to Seattle from Alaska, was raised by this means, so called in and picked up the crew. Otherwise they might have been there yet.

Ben Springer is now holding down the third trick at KOK, vice F. W. Everett, who is on the *Mojave*. Which reminds me that a new 10-lb. brasspounder, by the name of Melvin Dale Watson, has arrived at KOK. HD claims this is the finest baby in captivity, so it must be true.

Dick Clark is still making the arc on the *Yorba Linda* turn hand-springs. For two trips from Los Angeles to Baltimore he worked KFS every night without fail. Dick is the one who worked KFS when 150 miles from London while on the *La Brea* last year. That was 6718 miles as the crow would fly, if it could, which is a pretty good record.

Frances Beaulio of the *Lake Treba* is down in New Orleans now, wearing a straw hat with the rest of the natives.

"Duke" Hancock is still chief at KHJ. Think we're going to get some stories about the real early days from him for the next issue.

W. R. Reynolds, who has been operator on the new carferry WDK since she came out last spring, has resigned and gone away to school at Ann Arbor, Michigan. Good luck to you OM.

W. A. Stelzer of WDP and 8CPM has done a similar stunt. He is going to school at Lansing, Michigan. We miss his good fist.

"Doc" Kinne has been transferred from WDN to WDK.

That fast sending you hear from WFK is not done with a machine, it's C. O. Slyfield trying to make the bearings of his bug warm enough to heat his coffee on. The stuff makes our fone cords smoke and we are forced to use asbestos pencils when he's in a hurry.

Sez KZU: "Be brief."

We hope that the principal countries of the world will soon recognize the value of "WA, AA, Morse C" and other combinations that would mean a great deal more if they were made standard.

FROM THE RADIO MANUFACTURERS



The Silver-Marshall Type 316 Condenser is adapted to either single or gang mounting. In the latter case the shifts interlock in any desired position so as to allow control of two or more condensers from a single dial. A single die-cast U-shaped frame is used, providing

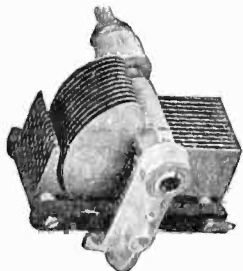

cone front and rear adjustable bearings. Provision is made for either single or double-hole panel mounting and two-hole base-mounting. Plates and bearings are of brass.

The Radio-Pep "B" battery eliminator comprises a step-up transformer, eight electrolytic cells with an improved compound electrolyte, choke coil, six large condensers and six binding posts. From the 60-cycle, 110 volt a.c. lighting circuit



it supplies direct current for plate supply at 45, 67, 90 and 135 volts. The only attention required is the occasional addition of distilled water to the electrolyte.

The Centrallab Modulator Plug is a new device that can be quickly attached, without tools, to any radio receiver having

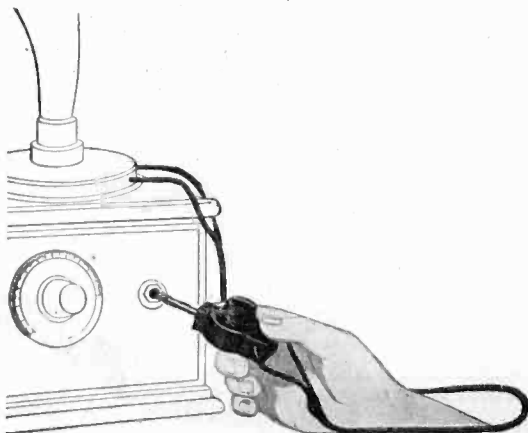

one or more jacks, and provides gradual control of tone volume from a whisper to maximum. In appearance it is slightly larger than the average phone plug, with a small bakelite knob on one side. Turning the knob through an arc of approximately 300 degrees varies a smooth graphite resistance in the plug base. This in turn controls the tone and volume.

The Benjamin straight line frequency condenser is designed to spread the radio-cast band of frequencies evenly over the entire dial. The rotor and stator plates are of die-stamped brass and are solidly braced in a cast aluminum frame. The turning tension is adjustable by means of

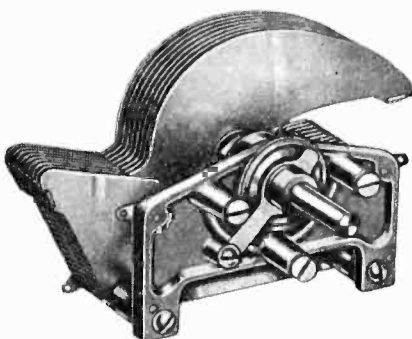

a thumb nut which does not loosen or throw plate out of alignment. The condenser may be grounded so as to eliminate body capacity and is adaptable to any type of set. It is furnished in .00025, .00035 and .0005 mfd. capacities.

The "No-bat-ry" electric radio receiver may be operated directly from electric light current. It uses five tubes and is

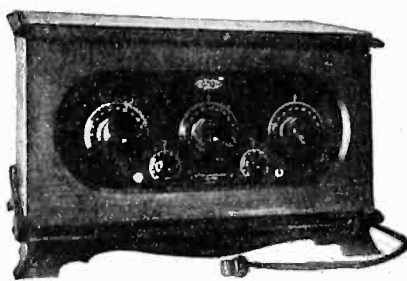

claimed to have clear tone, good volume, marked selectivity, good distance, and easy tuning.

Stored automatic radio power supply is a complete unit consisting of an "A" storage battery charger and a "B" battery eliminator supplying rectified and filtered current from the alternating current line. It may be placed at any distance from the set as it is controlled entirely by the switch which turns the set on and off, no other switch being required to start or stop the device. When the



set is turned off the charger immediately starts to bring the "A" battery back to full capacity, when charging is stopped by means of automatic control. When the set is turned on current for the "A" circuit is drawn from the storage battery and for the "B" circuit from the rectifier.

The Na-Ald No. 420 Connectorald facilitates the substitution of a UX120 tube in a UV199 socket for the last stage of audio. Thus a power tube can be used without changing any wires in the set. The device is provided with the necessary cables for attaching the additional "B" and "C" batteries necessary.

NEW RADIO CATALOGS

"Radio Tubes in the Clear Light of Modern Research" from the Cleartron Vacuum Tube Co. of New York City presents an unusually clear and simple explanation of the various functions of a vacuum tube, concluding with specific references to the tubes made by this company.

Engineering Circular No. 9 from Burgess Battery Co. gives test results of milliamper hours of dry battery service on intermittent and continuous discharge.

Burton-Rogers Co. of Boston, Mass., are distributing an eight-page circular describing the varied uses of the Hoyt Radio Meter which combines in one convenient unit five ranges necessary for all testing on radio receiving sets, tubes, batteries, battery chargers and battery eliminators. Complete directions, with diagrams, are given for each of these current and voltage tests.

BOOK REVIEWS

"Practical Radio" by James A. Moyer and John F. Wostrel, 271 pp., 5x7½ in., published by McGraw-Hill Book Co., New York City. Price \$1.75.

This, a new second edition, gives useful facts for users of receiving sets. It explains in simple terms the fundamental electrical principles entering into the operation of the various parts of a radio set and how troubles may be diagnosed and remedied. Other radio subjects of general interest, direction finding, fading, interference and static are explained in simple language. The text is a good introduction to the subject for a novice.

"Wireless Telephones" by James Erskine-Murray, 84 pp., 5x7½ in., published by Crosby-Lockwood & Son, London, England. Price \$1.50.

In the course of its nine chapters this little book details the processes whereby we hear the sounds made before a microphone. Considerable space is devoted to historical matter and to prophecy of future developments. It includes a glossary of technical words.

Breslau Station Increases its Power

The radio station at Breslau has increased its power to ten kilowatts and its antenna system is being supported by a higher mast of 325 feet. These changes should allow the east coast American listeners to hear this station when conditions are suitable.

AMERTRAN

TRADE MARK REG. U.S. PAT. OFF.

DE LUXE

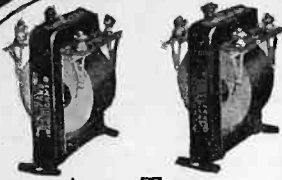
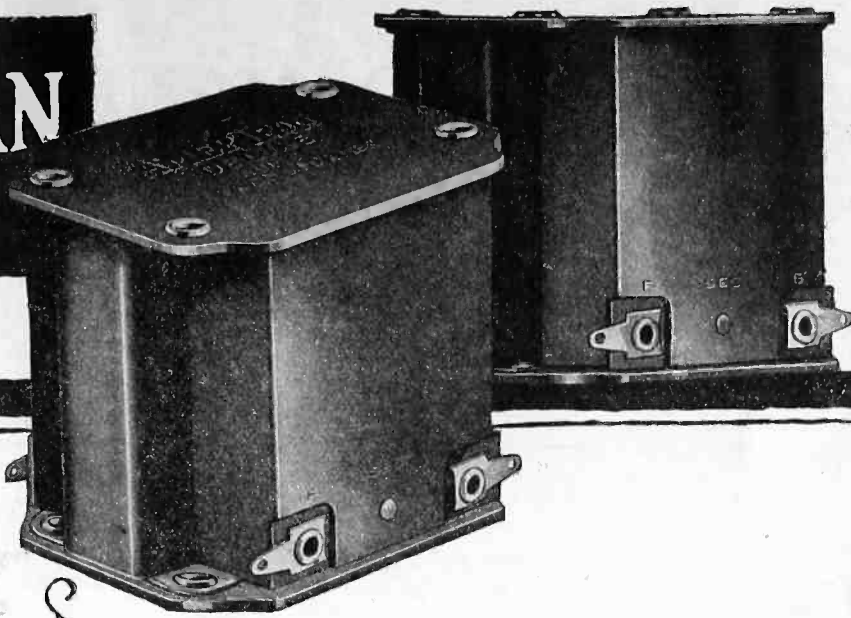

AMERTRAN

Types AF-7 and AF-6

AmerTran audio transformers Types AF-7 and AF-6 have been considered for years among the leaders in audio amplification. These popular and efficient models may now be purchased at a considerable saving in cost. Types AF-7 (ratio 3 $\frac{1}{2}$:1)—AF-6 (ratio 5:1) . . . \$5.00 each

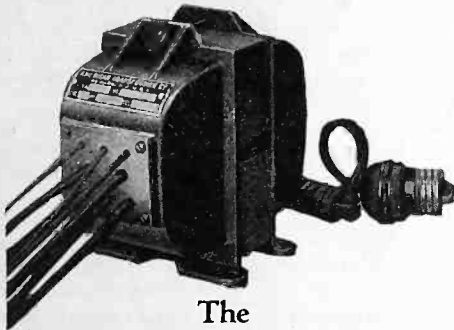

The AMERTRAN Power Transformer

Type PF-52, 65 VA—60 cycles
110/118/125—525—8/4—8/4

Type PF-52 is intended for use in converting the standard 110 volt, 60 cycle alternating house lighting current to a higher voltage for the plate and low voltages for filament supply. It can be depended upon to give good results when used in connection with the different tubes now available, and is designed with the usual margin of safety.

AmerTran Power Transformer type PF-45 is another transformer of the AC power type, similar to type PF-52 except that it has a plate winding for 450 volts AC and is without a metal ground shield between the primary and secondary winding. Price, Type PF-52, \$18.00; Type PF-45 . . . \$15.00

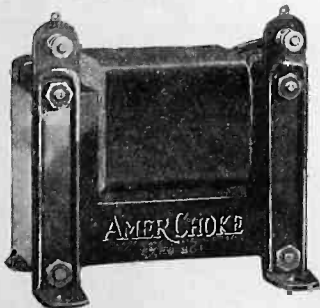

The New AMERCHOKE

Type 854

Type 854 is a scientifically designed impedance or choke coil of general utility, designed primarily for use in filter circuits. As an output impedance for by-passing direct current from the loudspeaker it is just as efficient and more economical than an output transformer. When used with a 1 mfd. (or greater) fixed condenser, the tone quality equals that of the best output transformer. DC saturation is prevented by two adjustable butt joints in the core. \$6.00 each

A New Standard of Excellence

For more than twenty-five years, the American Transformer Company has specialized in the manufacture of transformers. The transformers used by Marconi in his first trans-Atlantic tests in 1904 were made by this Company. Since that time the engineering staff has directed a large share of its resources toward the development of transformers for radio use. In 1921 the AmerTran Audio Transformer set a definite standard of excellence in its field.

The last five years have seen radio develop rapidly. Better tubes, broadcasting, and acoustical apparatus have brought these phases of reproduction nearer to perfection than ordinary transformer, impedance or resistance audio amplification.

When the new AmerTran DeLuxe Audio Transformer was recently introduced it put the "audio side" ahead of broadcasting facilities and reproducing instruments. Faithful amplification with natural quality thus, has again established AmerTran as the mark of a "new standard of excellence."

Combined with the new tubes, cone speakers, and clear signals from the detector tube, the AmerTran DeLuxe will reproduce natural volume over the ENTIRE audible range. The AmerTran DeLuxe is made in two types, one for the first stage and one for the second stage, and plainly marked as such. Price, either type, \$10.00.

Specified by leading Radio Engineers in their 1926 sets, the demand for DeLuxe transformers is already in excess of the supply. It is hoped that those who contemplate building the new Best circuit described in the April issue of "RADIO" will place their orders at once as deliveries are made in the order of their placement.

AND NOW, as Radio Reception is further simplified and refined, the American Transformer Company offers another major contribution.

The AmerTran Power Transformer and the AmerChoke make it possible and economical to use the new 7 $\frac{1}{2}$ volt power tubes in the last audio stage. The filament of this tube is lighted direct from this transformer. The Power Transformer also has a filament supply winding for the rectifying tube and supplies sufficient plate current, after rectification, for the operation of the set.

As the receiving set of the future is destined to be power operated—the American Transformer Company offers the above apparatus as units which in quality and design are best adapted for use in the type of audio amplifier required.

For use in building, experimenting and manufacturing these new AmerTran Radio Products assure dependability and satisfaction—and furnish the most advanced construction in practical radio.

PRICE, EITHER TYPE, \$10.00

Write for descriptive booklet entitled "Improving the Audio Amplifier"

American Transformer Company

178 Emmet Street, Newark, N. J.

"Transformer builders for over twenty-five years"

PACIFIC COAST OFFICE:

Rialto Building, San Francisco, Calif.



Tungar is the easy-to-use charger

Anyone can clip a Tungar to a battery and plug it in on the house current. That's all there is to it.

Attach a Tungar at night—and have snappy batteries in the morning. It will not blow out Radiotrons.

It needs little attention. Only a dime's worth of current consumed for a charge. No wonder "Tungar" is fast becoming the word for battery charger.



Tungar is the original bulb charger. It is a G-E product developed in the Research Laboratories of General Electric.

The new Tungar charges 2, 4 and 6 volt "A" batteries, 24 to 96 volt "B" batteries, in series; and auto batteries, too. No extra attachments needed.

East of Rockies

Two ampere size \$18.00

Five ampere size \$28.00

60 cycles . . . 110 volts

Merchandise Department
General Electric Company
Bridgeport, Connecticut

Tungar

REG. U.S. PAT. OFF.
BATTERY CHARGER

Tungar—a registered trademark—is found only on the genuine. Look for it on the name plate.

GENERAL ELECTRIC

The Largest Net Paid Circulation

of any radio magazine on the Pacific Coast is being enjoyed by

RADIOCAST WEEKLY

Send for a free sample copy

PACIFIC RADIO PUBLISHING CO.

Pacific Building - - - - San Francisco, Calif.

ARE YOU A SUBSCRIBER?

Tell them that you saw it in RADIO

BEST'S FIVE-TUBE SUPER

(Continued from Page 14)

upper waveband setting of the oscillator for one station and the lower waveband oscillator setting of the other station would be useless, and only one waveband of each station could be used. If it so happened that still another station was 90 kilocycles higher than the higher of the two above named stations, then it would be very difficult to receive the middle of the three stations, although either the highest or lowest station could be received on one waveband.

This is exactly what happens in many superheterodynes where the intermediate frequency is not right for the particular local conditions, and the owners complain of lack of selectivity, whereas the set was actually sharp in loop tuning, and the intermediate amplifier circuit was excellent as regards selectivity.

How then can this trouble be overcome? Simply by selecting that frequency which is best adapted to local conditions. For example, California has several powerful stations exactly 60 kilocycles apart, resulting in interference between locals when the filter is tuned to exactly 30 kilocycles. Chicago has a number of stations 90 kilocycles apart, making sets tuned to exactly 45 kilocycles unselective at certain settings of the dials.

For the convenience of the readers, the following recommended frequencies have been worked out, based on the present wavelength assignments, and taking into consideration the stations having an output power of 1000 watts or more:

New York, and vicinity—34, 37 or 80 kilocycles.

Chicago and middle west—28, 32 or 56 kilocycles.

Rocky Mountain states—32 or 45 kilocycles.

Pacific Coast—37, 45, 55 or 80 kilocycles.

The above data cannot be taken as arbitrary, as no doubt any frequency can be used, if interference between wavebands on the oscillator condenser, for certain settings of the dial, is not annoying, but the information is published to enable the set constructor to wind the filter transformer to take care of his particular condition. From the data given for the filter, frequencies higher or lower than those specified can be obtained by adding to or subtracting a few turns from the primary winding. The final adjustment can be made when the set is tested, and if interference from wavebands on the oscillator dial is noted, the change in the filter can be made until the wavebands separate sufficiently so that proper selectivity is obtained.

Practically any intermediate frequency transformer with an iron core is flat for 5000 cycles either way from the frequency at which it is best, so that in sets

(Continued on Page 44)

ELECTRAD

Certified Radio Essentials

Specified for "THE BEST 5-TUBE SUPER"

Endorsed by GERALD M. BEST, Technical Editor, of RADIO

Electrad Certified Mica Condenser

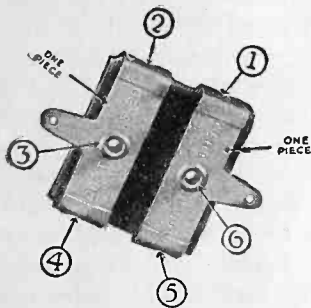

"The Six Point Pressure Condenser"

This is the famous "Six-Point Pressure" Condenser, without an equal for consistent performance. Uniform pressure insured by rigid binding at six points. Sheet copper—not tin-foil—soldering iron can't hurt it. Certified electrically and mechanically. Guaranteed to remain within 10% of calibration. Standard capacities—all types. In sealed packages, list 30c to 75c—in Canada, 45c to \$1.10.

Electrad Certified Filament Switch

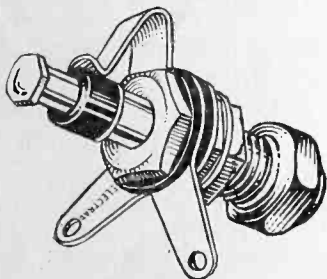

When it's on, it's 100% on; when it's off, it's 100% off. A better switch. Solid brass construction. Tinned soldering lugs, placed to make good connections easy. Neat design, genuine Bakelite knob. Requires less than 1" behind panel. Price, 40c—in Canada 60c.

Electrad Royalty 50,000 ohm Variable Resistance---Type C

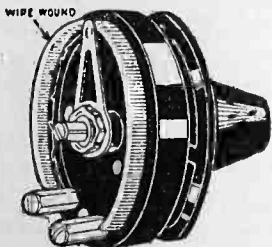

Note these important features: Wire-wound. Genuine Bakelite base. No parts to wear, break or lose electrical efficiency. Resistance remains constant at every point. Made in various types and ranges. Write for circular and special hook-up diagram, sent free on request. Price \$1.50—in Canada \$2.10.

Electrad Certified Single-Circuit Jack (Open)

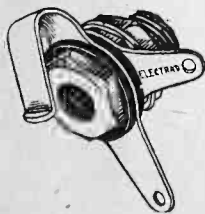

The jack you can depend on. Positive acting spring of phosphor bronze. Tinned soldering lugs, placed to make good connections easy. Requires less than 1" behind panel. Certified and guaranteed electrically and mechanically. Price 25c—Canada 35c.

Electrad Metallic Grid Leaks

Clearer reception with greater signal strength. No carbon, paper, varnish or fiber. The metallic resistance element is fused to the inside of a glass tube. Noiseless, non-inductive, constant under any weather, temperature or working conditions. Permanently accurate. Non-hydroscopic. Paraffined under high vacuum. Capped with the exclusive Electrad ferrule. Sizes 1 to 10 megohms, price 60c—in Canada 85c.

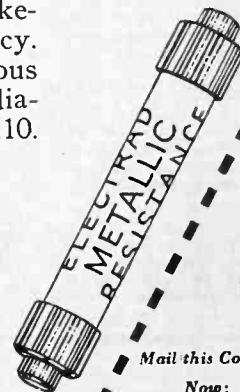

Mail this Coupon Now:

ELECTRAD, Inc., Dept. A, 428 Broadway, New York:

Send me complete instructions and working data on how to build "THE BEST 5-TUBE SUPER" for which I enclose 5 cents in stamps.

Name.....

Address.....

City.....

State.....

ELECTRAD, Inc.

428 Broadway, New York

Manufacturers of Electrad Certified Radio Essentials and Accessories.

Write for circular.

WEEKLY CALL BOOK

and Station Program

AT LAST a Call Book corrected weekly, to take care of the many weekly changes made by broadcasters in wavelength, location and operating hours. Only a weekly book can keep you fully posted on the many changes. It also gives you a list of new stations as they "come on the air." As many as fifty changes a week are made in this new book to keep up-to-date station listings and as many as 300 changes in schedules are made every week. As a radio listener, you know what this means to you. The book is published by the publishers of "RADIO." It is known as "RADIOCAST WEEKLY."

IMPORTANT INFORMATION Every week in this 96-page book you get the "AROUND THE DIAL" station log, distance chart, spaces for dial recordings, wavelength, power, location and owner of station.

The popularity of this book has made it necessary for us to issue 53,000 copies weekly. It is sold by news dealers in 2500 cities and towns on the Pacific Coast. Now you can also get this magazine by subscription, 52 issues mailed to your home (one copy a week for a full year) cost but \$3.00. It's worth a lot more.

GREAT OFFER Send us \$3.00 today for the next 52 issues. If you don't like the book you get your money back without question.

10c

96 Pages a week mailed right to your home for 52 weeks for only \$3.

Ten Radio Points for 10c

- 1—The list of important radio stations of the U. S.—corrected weekly and kept up-to-date. This is a "CALL BOOK" in itself.
- 2—The location of stations, their power and wavelength. This tells you, at a glance, just what reception you may expect.
- 3—The distance of important stations from various important centers along the Pacific Coast. This tells you how far you are receiving.
- 4—The operating hours of the stations within audible radius of Coast listeners. A speedy and accurate method for "what's on the air."
- 5—The listing of stations by wavelength, starting with the minimum operating wave and ending with the maximum. Use this for dial settings.
- 6—Logging spaces for "stations heard." Space is provided for three

dial readings, enabling you to quickly locate a station when you want to.

7—Listing of Canadian and Mexican stations. This is worth a lot to the listener who can "reach out." These listings are up-to-date.

8—VERY IMPORTANT is the weekly correction feature of the above high lights. Accuracy and reliability are responsible for the success of this magazine.

9—The listing of station programs by the day. Large headings in black type enable you to quickly locate the station you are after.

10—And—last of all—you get this data every week in "RadioCast Weekly," the reliable guide to WHAT'S ON THE AIR. The simplest form of schedules and the handiest reference book of its kind on the market. It costs 10 cents.

53,000 Copies Weekly Circulation

"RADIOCAST WEEKLY"

—Published Weekly by—

Pacific Radio Pub. Co.

PACIFIC BLDG.
SAN FRANCISCO
CALIFORNIA

1411-F ALTA VISTA
BOULEVARD
HOLLYWOOD, CALIF.

Sample Copy for 10 Cents

FROST-RADIO

No. 530 Socket

for all new type tubes

The new No. 530 **FROST-RADIO** Socket takes ALL of the new type tubes. It is made from black polished Bakelite, and has sturdy contact springs which hold the tube prongs for almost their entire length. Price 40c at your nearest dealers.

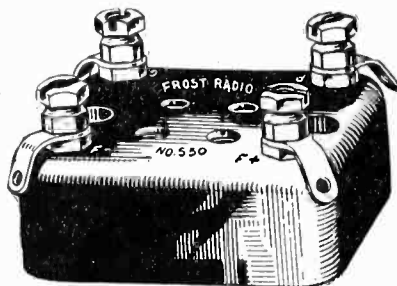

The No. 530 is a rich-looking socket because it is made from real Bakelite. Takes all the new type tubes. Price 40c

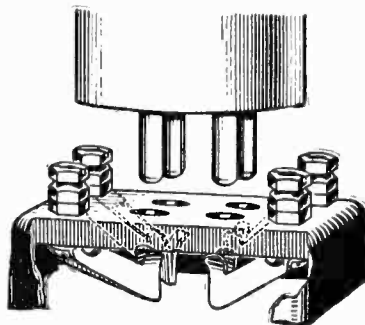

Note the spring construction as revealed by this cut-away view. These sturdy springs are held between cast bosses, and stay put.

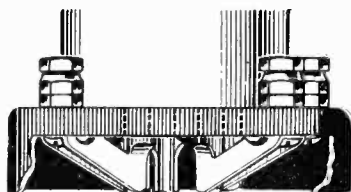

When the tube is inserted each prong is gripped the full length on two sides and held in a vice-like grip. Dirt cannot remain on the springs or prongs here.

HERBERT H. FROST, Inc.
314-324 WEST SUPERIOR ST., CHICAGO
New York City Cleveland Kansas City
Los Angeles

Export Office: 314 W. Superior St., Chicago

A Laboratory Product



CRESCENT LAVITE RESISTANCES

for Distortionless Amplification

Insure distortionless amplifications and a clarity of tone not obtained through any other resistances. All capacities 12,000 ohms and up. List price \$1.50. Special sizes to order. Write for full information.

CRESCENT RADIO SUPPLY COMPANY
3 Liberty Street, Jamaica, N. Y.

EXTRA COPIES OF THIS ISSUE
of "RADIO"

can be obtained from the publishers
at 25c each.

"RADIO" : : : San Francisco

(Continued from Page 43)

already constructed, and not now sufficiently selective, one of the filters here-in described can be tuned to the desirable local frequency without affecting the operation of the intermediate transformers.

In wiring the set, the filament leads, negative *C* battery and positive *B* battery wires may all be bunched together, and flexible insulated wire is most convenient to use. If all these wires are in bare copper, with spaghetti, a most complicated maze will result, difficult to repair and unsightly. As the r.f. currents passing through these insulated wires are all returning to a common terminal, the ground, the capacity between bunched wires is of no account.

The grid and plate wires, oscillator wiring and the antenna system, as well as the leads to the crystal detectors, should be in bare copper wire, kept away from other wiring and away from grounded apparatus. The pictorial wiring diagram, while distorted to show all connections, will enable the inexperienced constructor to connect the apparatus together without difficulty, and shows the actual terminal connections of each piece of apparatus used in the experimental model. Where wiring passes through the shelf, a hole drilled with a No. 28 drill should be large enough to pass the wire. As the shelf is of bakelite, no spaghetti or other insulation is necessary.

After the set is finally assembled, the filament circuit should be tested before connecting the batteries. Place one of the "A" tubes in each socket in turn, having the *A* battery connected. Then remove the positive *A* battery lead from the positive *A* binding post and connect it successively to the positive 45, 90 and 135 volt binding posts. If the circuit is o. k. the tube filament should not light. If the filament lights, ever so dimly, there is a short circuit somewhere and it should be located before the *B* battery is finally attached. After checking the filament circuit, connect the *B* battery, and insert all the tubes in their sockets. Attach the antenna and ground to the proper terminals, and insert the two small flashlight cells in the clips provided for them on the carborundum detectors. These two batteries may be Eveready No. 935 cells, and will last from three to four months of continuous service. The drain from each of these batteries is about .7 milliamperes.

Plug in the headphones or loud speaker and set the secondary condenser to approximately half way around the dial. Make the coupling between the antenna and the secondary as loose as possible by adjusting the coupling coil knob on the front of the panel, and turn the oscillator dial back and forth until a station is heard. Adjust the station to resonance by setting all three dials in

(Continued on Page 46)

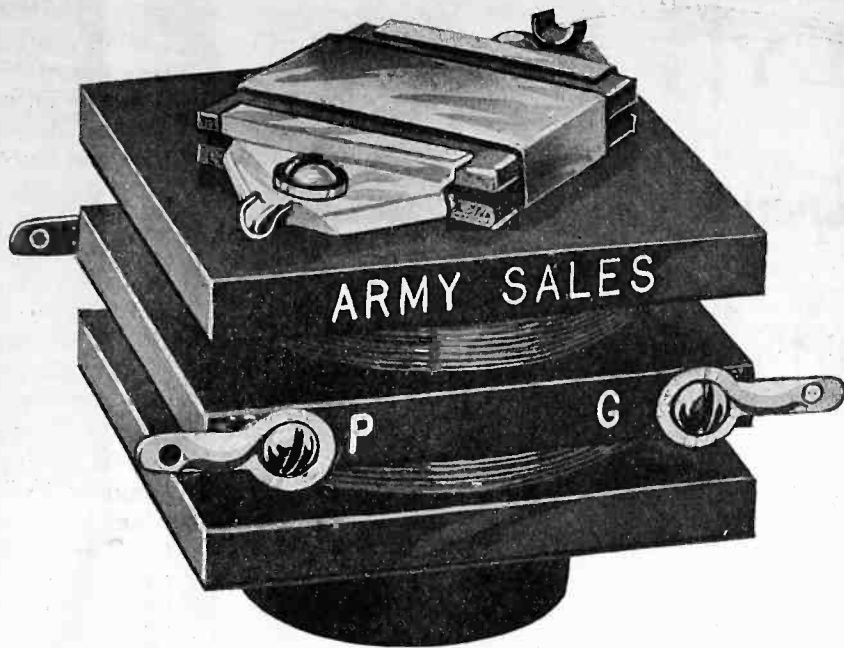

Best Filter Transformer

A Filter Transformer of Guaranteed Accuracy. Furnished with Matched Tuning Condenser. The first device of its kind obtainable which combines great selectivity with high step-up ratio. Adaptable to any circuit requiring filters tuned from 25 to 80 kilocycles. An improved arrangement of coil windings makes it possible to tune this transformer to any frequency between 25 and

80 kilocycles. Sets having poor selectivity—inefficient sets using improperly tuned filter transformers—improper matching of tuning condensers—can be greatly improved by the installation of the new Filter Transformer. Experiments are costly. Install one of these new Filters and note the difference. Each Filter Transformer is guaranteed fully—on a money-back basis.

Five Dollars, Postpaid

When ordering, please state type and frequency of the transformers already installed in your set. For new installations we will ship you the filter best adapted to the type of transformers you desire to use. Select the frequency best adapted to your particular locality. For extremely congested districts a pair of these Filter Transformers, matched to the same frequency, will enable you to cut out all local stations and bring in distance with remarkable ease.

Order by Mail

Send \$5.00 and your Filter Transformer and matched condenser go by mail same day your order reaches us.

Dealers

Our trade proposition will interest you. Write at once for complete information. Meet the demand for this device.

ARMY SALES COMPANY
1650 Jackson Street San Francisco, Cal.

(Continued from Page 44)

turn, controlling the volume by the volume control knob on the panel front.

The crystal detectors should now be adjusted. The frequency changer crystal will not be critical, and almost any setting of the potentiometer, except extreme minimum or maximum will be satisfactory. This is due to the large amount of energy being fed into the crystal circuit from the oscillator tube. The second detector crystal, however, is more sensitive, and a very well defined maximum point will be found a few degrees to one side or the other of the center tap. Set this slider to the sensitive point, and next adjust the oscillator coupling.

Turn the rotor of the oscillator-coupler to minimum coupling, and if the oscillator tube is functioning properly, enough energy should be induced into the pickup coil for satisfactory results. If a rather loud hissing noise is heard when the volume control is set at maximum and a distant station is being received, it is a sign that there is too much oscillator energy in the frequency changer circuit, and the coupling should be further reduced. Should the hiss still be objectionable, it can be further reduced by lowering the filament current of the oscillator tube by the introduction of the extra Amperite, as explained previously. Another method of reducing the oscillator energy is to reduce the plate voltage to 20, but this will necessitate the elimination of the C battery and the tube will emit bad harmonics which may interfere in tuning.

Should a high frequency singing sound result when the 2nd detector is set at maximum sensitivity, it is a sure sign that the 1st audio transformer needs a 1/2 megohm grid leak across the secondary. A low frequency howl is usually caused by coupling between the tubes and the loud speaker, but as there is no vacuum tube detector in the circuit, this howl should not occur.

Body capacity may be experienced when tuning the oscillator dial. This is caused by wrong connections of the grid and plate of the oscillator. The oscillator plate should be connected to the rotor and the grid to the stator, as the grid is sensitive to capacity effects and trouble may be experienced when tuning distant stations if the above connections are not made correctly. A small metal shield back of the three tuning controls is an added preventive to body capacity, but ordinarily is not needed if care is exercised in wiring the set.

If the antenna condenser will not tune to 550 meters, the antenna loading coil is not large enough, and the number of turns should be increased. If the reverse is true, turns should be removed until the maximum capacity of the condenser will just tune the set to 550

(Continued on Page 48)

THE Dependable B-POWER

Constant-B

Replaces Your "B" Batteries Permanently

AFTER installing the All-American "Constant-B" you need only snap the electric switch to have permanent and constant plate power for your radio, direct from the light socket. With it there is no ruinous acid, no hum—nothing but the pure, full tone that is only possible when the "B" voltage is constantly up to standard. Write for descriptive folder showing how to use "Constant-B" with any set.

Price \$45 COMPLETE WITH RAYTHEON TUBE

ALL-AMERICAN RADIO CORPORATION

Pioneers in the Radio Industry

4209 BELMONT AVENUE, CHICAGO, U. S. A.

Complete instructions for building a similar "Permanent Plate Supply Unit" may be had free upon request Specify Bulletin B-82.

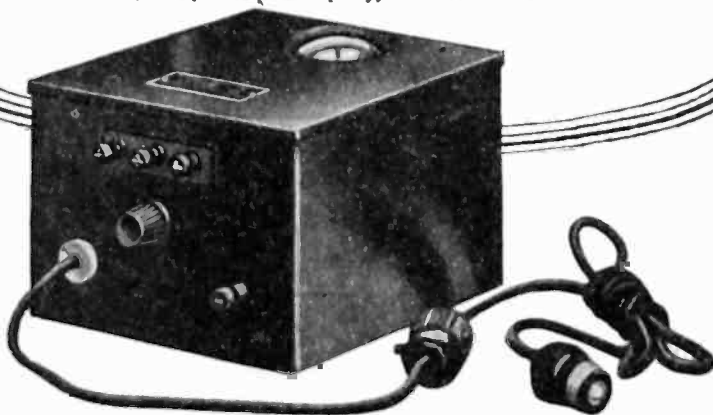

ALL-AMERICAN

OWNING AND OPERATING STATION WENR—266 METERS

Radio Built for the Years to Come

Safe! 

BRACH Vacuum Lightning Arrester

LINK YOUR SUPER

to an OUTDOOR AERIAL!

INCREASE YOUR RANGE AND VOLUME!
IMPROVE THE SELECTIVITY!

Write today for full information

The Superadio Co. 136 LIBERTY ST.
NEW YORK CITY

LATEST "COAST TO COAST" FULLY GUARANTEED

RADIO'S-10 DAYS FREE TRIAL

SAVE 1/3 TO 1/2

Users everywhere report Miraco Radios get programs coast to coast on loud speaker; outperform sets three times as costly. Many hear foreign countries. Radio's most amazing values in unconditionally guaranteed, factory-built long distance sets—let testimony of users convince you.

MIRACO RADIO GETS 'EM COAST TO COAST

Powerful New Multi-tube Miraco gets long distance on loud speaker. Set, ONLY \$27.35 retail

FREE! Literature on latest improved 1 to 6 tube models, new low prices, testimony of users and SPECIAL OFFER. Write: MIDWEST RADIO CORP'N Pioneer Builders of Sets 414-W E. 9th St. Cincinnati, O.

AGENT USERS WANTED Write for discounts.

ARE YOU A SUBSCRIBER?

Send for Trial Subscription
\$1.00 for Six Months

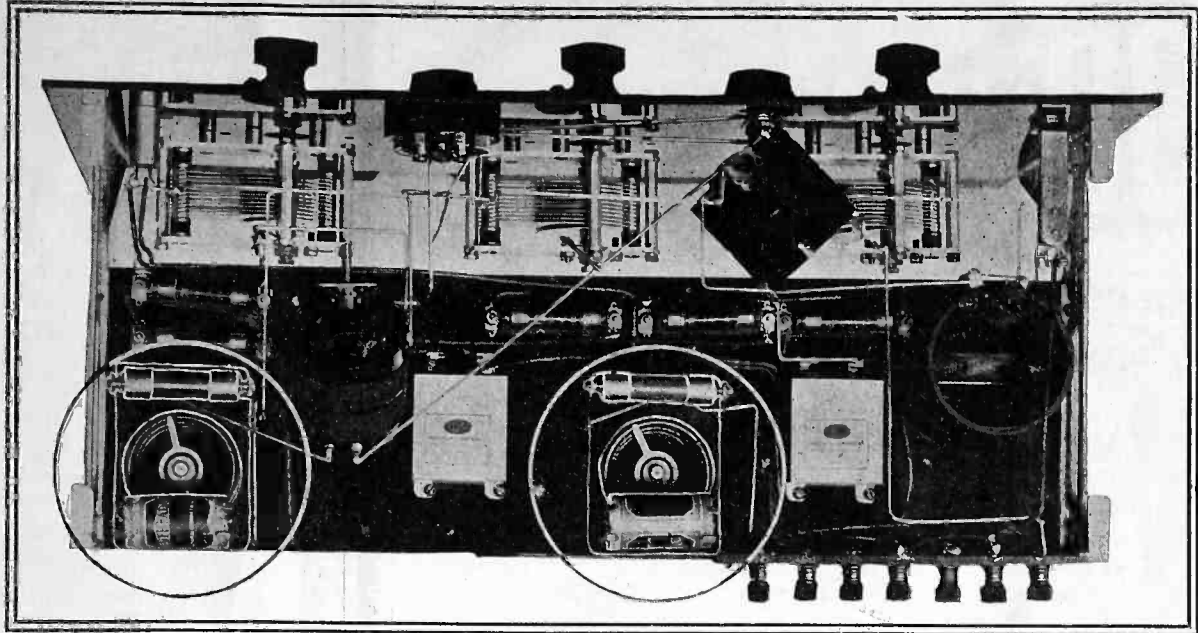

One of the Most Essential Parts in BEST'S Five - Tube SUPER-HET

THE CARBORUNDUM STABILIZING DETECTOR UNIT

In creating his sensational five-tube super-het, Gerald M. Best selects the only detector unit that gives perfect rectification—that is noiseless, sensitive, powerful and permanent.

Best uses two of the Carborundum Stabilizing Units in his new set, and he is frank to say that it can't be built without them.

The Carborundum Stabilizing Detector Unit is built around the Carborundum Fixed Detector. By a mere turn of the knob you adapt the detector instantly to the receiving conditions. There are no other adjustments. It will not burn out.

The Carborundum Stabilizing Detector Unit is absolutely essential in building Best's new five-tube super-het

**AND IT CAN BE USED IN ANY OTHER SET
WITH THE SAME ADVANTAGES**

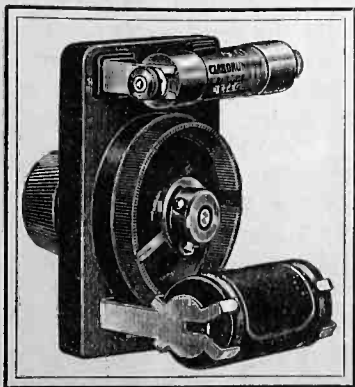

\$3.50 in U. S. A.
Without
Dry
Cell.

DEALER OR
DIRECT.

SEND FOR DESCRIPTIVE BOOKLET
SHOWING TYPICAL HOOK-UPS

The Carborundum Company
Niagara Falls, N. Y.

New York, Chicago, Boston, Philadelphia, Cleveland,
Detroit, Cincinnati, Pittsburg, Milwaukee,
Grand Rapids.

"THE BETTER CONDENSER"

Maintains Its Leadership

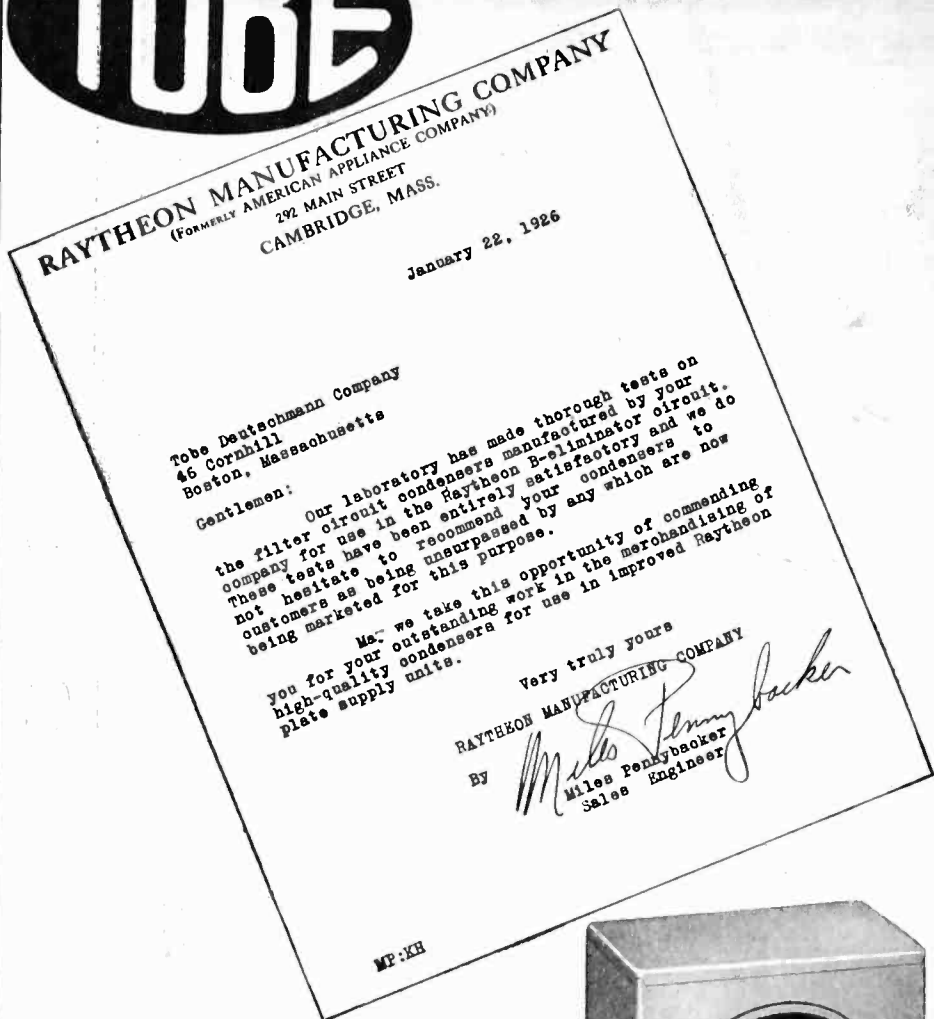

Make sure that you get the
**OFFICIALLY APPROVED
RAYTHEON**

FILTER CONDENSER BLOCK

The TOBE Condensers have been tested in the laboratory of the Raytheon Manufacturing Company and as a result they have written the letter reproduced above. It speaks for itself.

The new TOBE B BLOCK contains in one compact silvered metal case the three filter and two by-pass condensers required for the Raytheon B-Eliminator;—one 8 Mfd.—two 2 Mfd., two 1 Mfd. Price, \$11.00. It saves \$2.50 in the cost of parts—saves space—saves wiring. Ask your dealer for "THE BETTER CONDENSERS"

Send for free circuit diagrams of B-Eliminators

TOBE DEUTSCHMANN CO.
CORNHILL BOSTON, MASS.

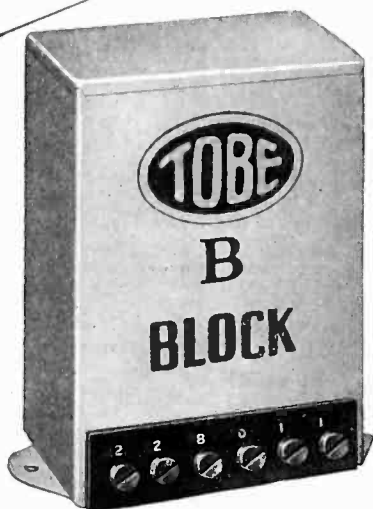

(Continued from Page 46)

meters. This adjustment will vary with different antennas, and the data given is for an antenna system having an over all length of 100 feet. A longer antenna will require less loading inductance and a smaller antenna will require more.

At this part of the story I am going to forestall about 9000 questions by answering them in advance. What changes are necessary in the circuit to employ vacuum tubes in the 1st and 2nd detectors, and how may a loop antenna be connected to the set? Fig. 8 shows how this may be done, using all storage battery tubes. If the loop antenna is not desired, use the antenna tuning arrangement shown in Fig. 2.

What changes must be made to use dry cell tubes, of the 299 and 120 variety? The only change needed will be in using the proper size of automatic filament resistance, and the installation of a 22½ volt C battery in the grid circuit of the last audio tube, which should be of the UX-120-CX-220 variety. A 4 or 4½ volt A battery will also be needed, but otherwise, no changes in the coils, condensers or other apparatus will be necessary, and the sockets shown in the pictures are adapted for use with either the dry cell or storage battery tubes.

Can resistance or impedance coupling be employed, and what changes will be necessary? It is not advisable to couple the 2nd crystal detector to the audio stages either by resistance or impedance coupling, and a high grade transformer is preferable in order to take advantage of the voltage step-up. The remainder of the audio amplifier may be either resistance or impedance coupled if desired, but there is not sufficient room on the sub-panel for the extra choke coils and the tube associated with the impedance coupled amplifier, and a larger panel would be necessary.

COIL COMPARISONS

(Continued from Page 30)

diameter as shown in the accompanying sketch. The pins were .1 in. in diameter with .4 in. between the pins in each pair. The coil was built up along the axis, just enough collodion being used to hold the coil together. This coil had a d.c. resistance of 1.21 ohms and an inductance to resistance ratio of 24.05 at 1000 cycles, 110 at 600 kilocycles, and 26 at 1500 kilocycles.

A similar loose-basket weave coil made up of No. 28 d.c.c. had a d.c. resistance of 3.19 ohms and an inductance to resistance ratio of 9.13 at 1000 cycles, 51 at 600 k.c. and 25 at 1500 k.c.

When a binder or "dope" was used to support the coils, collodion was found to cause less variation in properties than either varnish, shellac, or paraffin. It also has the additional advantage of drying rapidly.

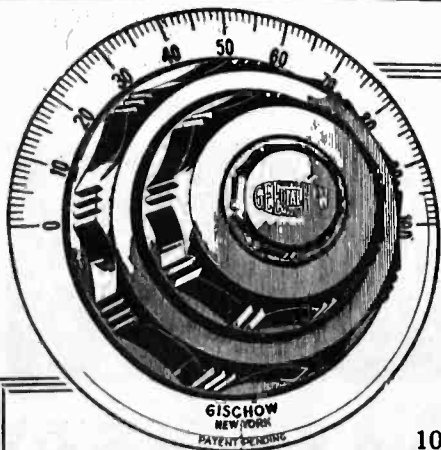

GEE-HAW Micrometer TUNING DIAL

Ratio 100 to 1
A New Mechanical Principle
Absolutely No Backlash

Manufactured by
OTTO R. GISCHOW CO., Inc.
New York

For Sample Write to Pacific Coast Agents:

American Commercial Co.
1067 Market Street, San Francisco, Calif.

Cardwell

Old Friends

With New Faces

are far more dependable than strangers.

The logical plate shape of a rotary variable condenser is semicircular, and to use these plates to the proper advantage, neither rotor nor stator should be cut away to any extent.

Cardwell Taper Plate Type "E" condensers have the old familiar plate shape, but have a straight frequency tuning characteristic.

Authorities agree that these condensers are the finest instruments ever produced. Mr. Arthur H. Lynch, Editor of "Radio Broadcast," selected them as ideal for use in the "Aristocrat" and other receivers. Mr. Gerald M. Best, Editor of "Radio," uses them in his new "Super."

The Type "C" approaches straight frequency at minimum but gives more separation at maximum.

They are priced the same—the .0005 mfd. capacity lists at \$5.00, and others, proportionately.

The Allen D. Cardwell Mfg. Corp.

81 PROSPECT STREET
BROOKLYN, N. Y.

5c. in stamps brings this booklet on the Best Super-Heterodyne.

If your dealer can't supply you, order direct. Write for illustrated catalogue and handbook.

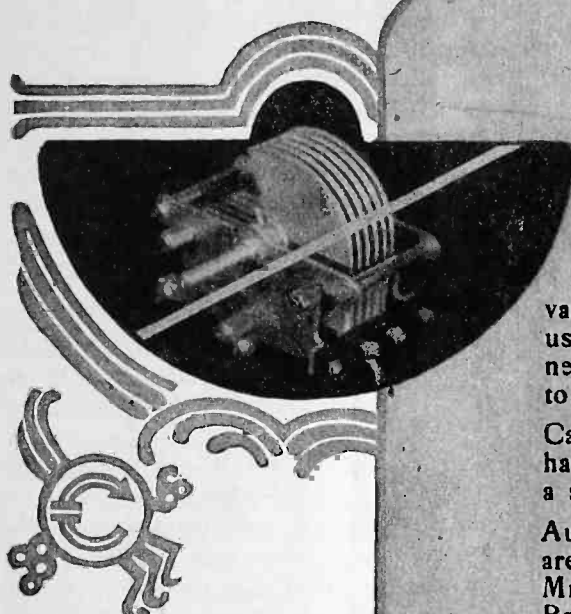

The Taper Plate Type "E" with straight frequency tuning characteristics

The Type "C" has a modified straight wave length tuning curve

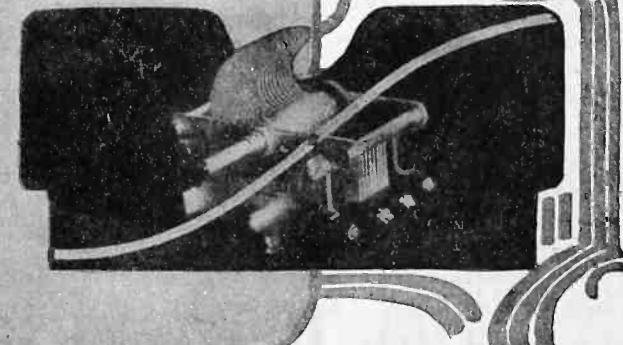

Condensers

"THE STANDARD OF COMPARISON"

Tell them that you saw it in RADIO

RADIO SERVICE KIT

(Continued from Page 18)

correct polarity. When plugged into an audio frequency socket the readings may be just noticeable, but when plugged into an R. F. socket full scale will be noted since the resistance in series with plate and grid meters are generally negligible. In case of a detector tube socket, it is necessary to short the grid condenser, also in resistance coupled amplifiers it is generally necessary to short the grid resistor. More sensitive instruments would eliminate the last necessity, but experience has shown that it is inadvisable to use the more expensive meters; as a short between the *B* and the *A* or *C* batteries in a set proves disastrous to the windings and pointer. With the cheaper ones the worst is generally only a slightly bent hand that can be easily straightened.

The small tools of the kit comprise the customary soldering iron, hydrometer, pliers, screwdriver, wrenches, etc. Two special tools are a neutralizing stick of insulating material and a pair of bakelite pliers. Condensers and resistors of various sizes are also included and used in substitution for test purposes, since meggers and capacity bridges are considered as shop instruments. A pair of headphones and the notebook completes the outfit. The notebook contains calibration charts for the wavemeter, radiocast station lists with respective wavemeter settings, current circuit diagrams, and technical information on such new apparatus as is available to the public, etc.

Taken as a whole, the outfit described has proven quite satisfactory and adequate for the demands upon it, although it is realized that there is much room for improvement. In superhet work a long wave oscillator is valuable, and the wavemeter could be supplemented with other coils so as to obtain wavelengths in range of intermediate amplifiers. Major troubles on supers, however are considered as shop jobs. The wavemeter could be improved by use of a straight line frequency condenser; also reduced in size by use of a 199 tube and smaller batteries. The circuit tester is unnecessary except as a time saver, since the same tests can be made by placing a voltmeter across the plate-filament, filament and filament-grid binding posts of the tube tester when attached to the various sockets of a receiver. If the milliammeter of the tube tester were supplied with shunts and multipliers as described by Mr. Lock in October RADIO, both meter combination and circuit tester could be eliminated, thus reducing the large units of the kit to two. In the interests of service, the writer would be pleased to receive criticism, constructive or otherwise, from those interested.

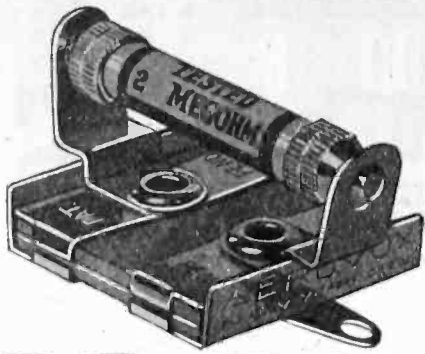

AEROVOX

FIXED CONDENSERS

"Built to be Better"

AEROVOX WIRELESS CORP.

489, 491, 493 Broome St., New York City

Chicago, Ill., 53 W. Jackson Blvd.
Cincinnati, Ohio, 304 Palace Theatre Bldg.

Branch Offices:

Boston, Mass., 104 Portland St.
Los Angeles, Calif., 391 N. San Pedro St.

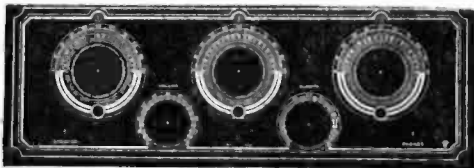

RADIO PANELS

Smooth, perfect edges, cut with
patented non-metallic saws

Highest quality panels cut, drilled, and engraved, to order. Only finest bakelite used. 3/16" thick, 2 cents per square inch. 1/8" thick, 1 1/2 cents per square inch. Letters engraved, 4 cents each; Arrows and Markers, 15 cents; Border-lines, 35 cents up; Dials, 50 cents up; edges bevelled, 35 cents up; Meter-holes cut, each, 50 cents. Send rough sketches for estimate.

8-hour service. We ship everywhere, mail orders solicited. Radio shops and set-builders write for discount-sheets.

Volney G. Mathison & Co.

660 Twelfth St.

Oakland, California

APEX VERNIER DIALS

Are Best on Any Set

Ask Your Dealer or Write

APEX ELECTRIC MFG. CO.

1410 W. 59th Street, Chicago

The Reason

THE TUBE WITH A SENSIBLE GUARANTEE

Quality! Performance Dependability

are the factors which made Supertron
the foremost Independent Tube in America !!!

Supertron promises the Radio public and the Radio trade—a revolution in the art of making tubes—a New re-enforced interior construction that will positively cure the present tube ailments. Non-microphonic—uniform—better and a complete line, all types.

All Types \$2.00

Canada, \$2.75

Try Supertron and Be Glad.
At Good Dealers.

Branch offices in principal cities
throughout the United States
Write for complete details.

SUPERTRON MFG. CO., INC.

Hoboken, N. J.

SUPERTRON
A SERIAL NUMBER GUARANTEE

IN-A-CAP HYDROMETER

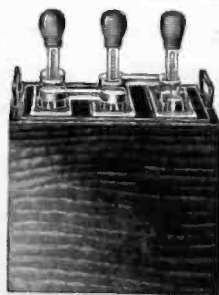

Stays permanently in your battery. Always ready and drip proof. No fuss or muss. No burned rugs or clothes, no stained floors or wet battery tops. Set of three \$2; single, 75c. At dealers or by mail post-paid.

Fits any cabinet by adjusting height of bolt.

IN-A-CAP HYDROMETER CO.
1343 W. 14th Pl., Chicago



PANELS

EXCLUSIVELY FOR

Gerald Best's Five-Tube Superheterodyne

Front Panel
\$7.75

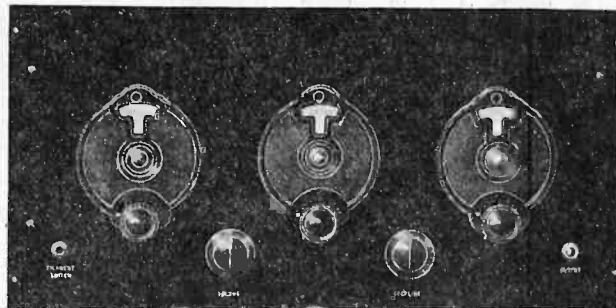

Sub-Panel
\$3.25

Standard Front Panel

SPECIFICATIONS: Front Panel 10x20x3/16. Bakelite Dilecto. Glossy Finish. Drilled, Countersunk and Machine Engraved. Sub-Panel Drilled and Countersunk. Both panels designed for standard parts for G. M. Best's Super. No cutting or fitting necessary.

We Are Also Headquarters for:

SILVER-MARSHALL
SILVER-COCKADAY
HAMMARLUND-ROBERTS
WESTERN ELECTRIC

Standard Lines of Sets and Parts.

Send 10c for Catalogue

Dealers and Jobbers—Write

USE THIS COUPON

WIRELESS ELECTRIC CO.,
206 Stanwix Street,
Pittsburgh, Pa.

Gentlemen:—I enclose \$11.00, for which please send me Parcel Post—

1 Standard Front Panel,
1 Standard Sub-Panel,

drilled and engraved for Mr. Best's five-tube superheterodyne.

(C.O.D. orders must be accompanied by 25% deposit.)

Name

Address

WIRELESS ELECTRIC ©

206 STANWIX ST.
PITTSBURG, PA.

DISTRIBUTORS

SERVICE

ENGINEERS

SM

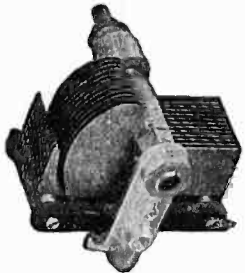

Type 316 Condenser, .00035 Mfd. for single or gang control. Brass plates, die cast frame. Price, \$5.75.

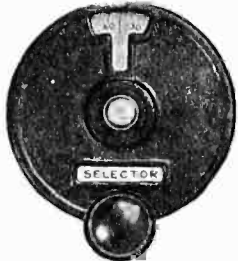

Type 801 Universal Vernier Dial, Ratio 14.5:1. Fits any standard condenser right or left, 180 or 360° movement. Price, \$2.50.



Interchangeable Coils for any wavelength. Standard Sizes, \$2.50. Type 515 Coil Socket, \$1.00.



Type 510 All-Bakelite Socket for UX tubes, 50c.

S-C

It is not remarkable that McMurdo Silver, Laurence M. Cockaday and the engineers of seven important manufacturers should choose S-M parts wherever possible for the S-C Receiver.

That was a foregone conclusion for they knew that S-M equipment was dependable—to the last detail *right*.

That is why, in practically every successful receiver design of past and present seasons you will invariably find S-M apparatus—depended upon and *dependable*.

SEE Handle S-M Parts at your dealers. Find out for yourself exactly why they are selected and endorsed by experts and engineers.

Silver-Marshall, Inc.

106 S. Wabash Ave., Chicago



Type 340 Compensating Condenser, .00025 Mfd. with knob, \$1.50.

ROLL YOUR OWN

(Continued from Page 20)

he was dressed for work, he'd say: "How do I look?"

"Fine."

"How's my tie?"

"Fine."

"How do you like this new tux?"

"Fine."

"You love me?"

"Yeah."

"Are you happy?"

"Yeah."

"Going to the movies tonight?"

"Yeah."

"Gonna think of me?"

"Yeah."

"Got anuff money?"

"Yeah."

"Shall I wake you up when I get home?"

"Yeah."

"All right, Dolly. Good-bye, Dolly."

"Good-bye, Melville." That was the name he answered to around the house. At the Mansher Hotel, where he sobbed jazz breaks nightly, they called him Sobby.

The next morning Sobby cut his beauty sleep a couple of hours and, with Dolly as an innocent bystander—and there never was a more innocent bystander than Dolly—started "rolling his own."

After four hours of hard labor, during which time he burned eight fingers and two thumbs and fifteen holes in the table cloth and used up about a yard of solder, the autoplex was finished. Outside of the big blobs of solder on the joints, it looked pretty good—from the front, at least. Then they repaired to the yard and hung the aerial. That took almost up to supper time. However, everything hath an end, and a radio tube usually has but one. The wires were hooked to the binding posts and, strange to relate, it worked. It whistled like a fiend when a station was tuned in, but, hot jazz breaks! it worked.

"Oh, Mel," cried Dolly, clapping her hands, "ain't that lovely! Now I can sit home and listen to you play. You're the cleverest boy!"

There was no limit to his cleverness. He was clever and admitted it to all the jazz break hounds with whom he worked. He came home from work with his pockets full of radio magazines. The radio bug had sunk its claws into him and he was on his way to become an expert.

The first radio magazine that he read stated that the autoplex was all wet, and that it should be thrown into an alley and covered with ashes. "Now, here is a reflex," the article stated; "two tubes do the work of four, and—"

Immediately Sobby was made a convert to reflexes. The autoplex didn't look so good to him. As he inhaled the

(Continued on Page 54)

ARE YOU A SUBSCRIBER?
SEND FOR TRIAL SUBSCRIPTION
\$1.00 FOR SIX MONTHS

Filter Condensers

for "B" Supply Unit

All sizes—All specifications—Meet all requirements—Made in three voltage ranges. Full specifications and details at your dealer's or direct.
POTTER MANUFACTURING CO., North Chicago, Ill.

Potter

By-Pass and Filter
Condensers
(An American-Made Product)

A SUBSCRIPTION TO
"RADIO"
INSURES REGULAR
RECEIPT OF COPY

PATENTS

S. GOLDSTEIN
Registered Attorney
Formerly Member of Examining Corps,
U. S. Patent Office,

1440 BROADWAY, N. Y. CITY

PATENTS—TRADE MARKS

Prompt Service—Write for Particulars

First in the Field
Specializing
in Cockaday Kits

STAR RADIO CO.

322 BERRIMAN ST.
BROOKLYN, New York

HERE IT IS! BEST FIVE TUBE SUPERHETERODYNE

As Described by Mr. Best in This Issue of "RADIO." The Following Are the Exact Parts Used in the Construction of the Original Model. Save Money—Save Time, Work and Worry.

EASY TO BUILD WITH OUR "READY-TO-WIRE" PLAN.

THE PLAN—All you need to do is to connect bus-bar according to diagram, solder and your set is finished. These parts are sent to you completely mounted and assembled on a Veneered Mahogany baseboard and genuine bakelite panel, drilled and engraved, in a solid Mahogany Cabinet. Nothing else to buy, to assemble. Genuine parts listed below, exactly as used in Mr. Best's Laboratory Model.

- 3 Cardwell .0005 Variable Condensers, New Type.
- 2 Tobe Deutschmann 1 mfd. Condensers.
- 4 1-A Amperites.
- 1 112 Amperite.
- 1 Electrad Jack.
- 1 Electrad Filament Switch.
- 1 Electrad .002 Fixed Mica Condenser.
- 1 Electrad 1/2-megohm Grid Leak.
- 1 Electrad .006 mfd. Fixed Condenser.
- 2 Amertran DeLuxe Transformers.
- 5 A Tube Sockets, General Radio.
- 1 General Radio Antenna Load Coil, Type 277E.
- 1 50,000 Ohm Electrad Resistance (Royalty).
- 2 Kurz Kasch Knobs.
- 2 Kelbrackets No. 7.

- 2 Carborundum Crystal Detectors No. 32.
- 1 Army Sales Co. Filter Transformer.
- 2 Remler Intermediate Transformers No. 600.
- 2 Remler No. 620 Couplers.
- 3 National Vernier Dials, Type B.
- 1 General Radio Protector Resistance, 500 Ohm.
- 2 Eveready No. 751 "C" Batteries.
- 1 Panel 10x20" Bakelite Dilecto, Drilled and Engraved.
- 1 Sub-panel 5x18 1/2" Genuine Bakelite, Drilled.
- 1 Eby Binding Post Strip.
- Bus Wire, Screws, etc.

The Cabinet supplied with the Ready-to-Wire Plan is made of beautiful Walnut, piano finished, piano hinged. Made by Corbett.

Ready-to-Wire, Price \$91.

Unassembled, Price \$81.

The Following Kits in Stock:

Hammarlund Roberts Kits S-C Receiver

Raytheon "B" Eliminator McLaughlin Single Control SUPERHETERODYNE

Eliminate "B" Batteries—Build Your Own
Power Unit !

These Parts Were Used in Building the Laboratory Model of the "Power Unit."

- 1 Amertran Power Transformer, Type PF-52.....\$18.00
- 1 Amertran DeLuxe A. F. Transformer for Second Stage.....10.00
- 3 Amerchokes, Type 854.....18.00
- 2 Dubilier Filter Condensers, Type 769, 2 mfd. (Working Voltage, 400 Volts D. C.).....7.00
- 2 Dubilier Filter Condensers, Type 770, 4 mfd. (Working Voltage, 400 Volts D. C.).....14.00
- 4 Dubilier Filter Condensers, Type 766, 2 mfd. (Working Voltage, 160 Volts D. C.).....8.00
- 1 Aerovox Craig Resistor, Type 980.....4.00
- 1 Bradleyohm No. 25—25,000 to 250,000 ohms.....2.00
- 2 Patent Single-circuit Jacks, No. 61.....1.00
- 2 Benjamin Push-type Sockets, No. 9040.....1.50
- Bakelite Sub-base, 7x21x1/4", Drilled.....4.45
- Bakelite Binding Post Strip, 7x1x1/4"......35
- Angle Brass Reinforcement Strips for Sub-base, pair......75
- Angle Brass for Holding Binding Post Strip, pair......10
- Brass Brackets for Mounting Resistor Unit M, pair......35
- Brass Strip for Mounting Filter Condensers......35

KIT PRICE
\$70.00

Cockaday's New LC-26 Receiver

- 1 General Radio Variometer, Type 269, With Rheostat Knob.....\$ 5.30
- 1 General Radio Rheostat, Type 214-a, 7 ohms, With Rheostat Knob.....2.25
- 1 Precision Octaform Coil Set.....5.50
- 1 Amsco Double Unit Condenser, No. 1814.....6.25
- 1 Micamold Fixed Condenser, .00015 mfd......35
- 1 Micamold Fixed Condenser, .00025 mfd......35
- 2 Daven Resisto-couplers (New Type).....3.00
- 1 Amertran DeLuxe Transformer, First Stage.....10.00
- Bradleyleak, 1/4 to 10 meg.....1.85
- 3 Bradleyunits, 1/4 megohm.....2.25
- 1 Bradleyunit, 1/2 megohm......75
- 3 Amperites, No. 1a.....3.30
- 1 Amperite, No. 112.....1.10
- 5 Benjamin Standard "Cle-ra-tone" Sockets.....5.00
- 1 Carter Single-circuit Jack, No. 101......70
- 2 Carter Jack Switches, No. 2.....2.00
- 8 Eby Binding Posts.....1.20
- 1 Fynur Vernier Control Knob and Dial.....3.50
- 1 Universal Decorated Panel, 8x22 inches.....7.50
- 4 Small Brass Brackets.....
- 2 Bakelite Connection Blocks 1x2 plus 1x9.....
- 2 Large Brass Brackets......35

Ready-to-wire Kit, Price . . . \$62.50
Wired complete in Genuine Mahogany Cabinet . . . \$77.00

Write for complete information about these PARTS and KITS

All Prices Subject to Regular Discount!

Transportation prepaid. One-third must accompany all C. O. D. orders. Not insured unless insurance charges included.

Modernize Your Radio Set!

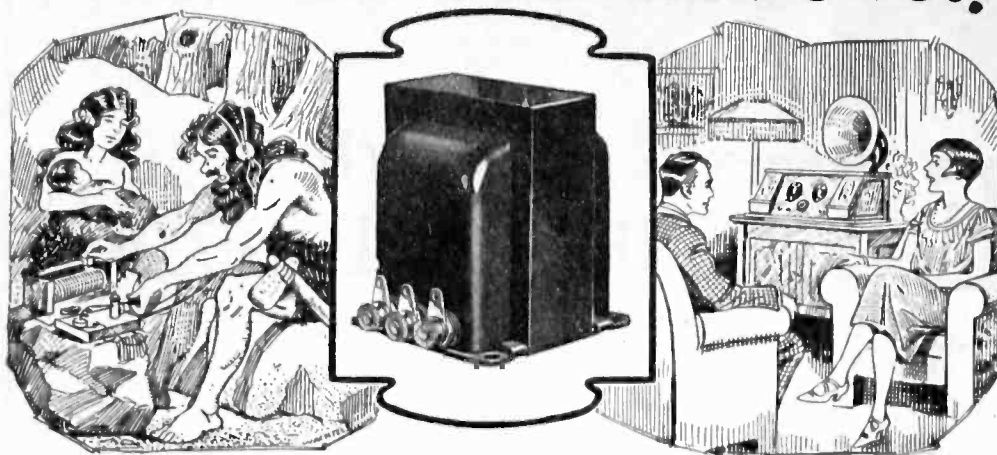

Write for free descriptive circular

THORDARSON

Autoformer

Trade-Mark Registered

Price \$5.00

All Frequency Amplifier

Are you still using primitive methods of amplification? Why not make your receiver an up-to-date model by installing Autoformer amplification—the ultimate in reproductive equipment?

The Autoformer, a step up impedance amplifier, reproduces with full volume those bass notes lost in ordinary transformer amplifiers.

The Autoformer provides the unrestrained flow of distortionless music. It records everything from the slightest shading to the greatest extreme of volume, intensity, and timbre.

Better volume control.
More volume on distant stations.
Full bass note amplification.
Greater clarity on all signals.

OTHER THORDARSON TRANSFORMERS

R-200 Amplifying Transformer
Standard Amplifying Transformers
Power Amplifying Transformer
Interstage Power Transformer

B-Eliminator Transformer
B-Eliminator Chokes
Battery Charging Transformers
Transmission Equipment

THORDARSON ELECTRIC MANUFACTURING CO.
Transformer specialists since 1895
WORLD'S OLDEST AND LARGEST EXCLUSIVE TRANSFORMER MAKERS
Chicago, U.S.A.



PRICE
\$20 each

The PHOTO-ELECTRIC CELL!

The PHOTOTRON

Instantaneous in response, fatigueless in operation, and permanent in sensitivity, this potassium-hydride photo-electric cell is just the thing for scientific research, picture transmission, and all light-actuated devices.

For Descriptive Literature Write

PHOTON ELECTRIC CORPORATION
247 PARK AVE. 1269 COCHRAN AVE.
NEW YORK, N. Y. LOS ANGELES

(Continued from Page 52)

dry radio magazines,—they were dry in those days,—he began to note the similarity between all the different circuits. They all looked pretty much alike.

"These things are a puddin' to make. Doll," he said.

"Yeah."

"Sure—look. They're all hooked up grid to plate."

"Yeah." She probably thought he was talking about flapjacks.

"Can't hook 'em up any other way."

"Yeah."

"I'm gonna make a reflex and get a loud speaker. You'll get your ears all sore from those ear phones."

"All right, Mel. I'll help you."

The lovely little helpmate was going to help him. That should be good.

Sobby made a trip to John's electrical shop and bought another load of junk. Arriving home, the autoplex was torn down and those parts that could be used in the reflex were salvaged. One variometer was a dead loss. This circuit was a little more complicated, but by hard, diligent work and the burning of fewer fingers and less holes in the table cloth and the use of two inches less solder he got it done in time to hook it up before he went to work. Dolly helped him all the time by handing him the wrong thing at the wrong time.

It whistled. Like a peanut roaster going full blast, it kept up one persistent and penetrating shriek.

"I know what's the matter with it," he told Dolly. "Leave it alone. I'll fix it tomorrow."

He thought he knew. As it persisted in whistling the next morning, he called John on the telephone.

"Ya got your rheostat pulled too high," said John. "And maybe ya need another crystal and you should ought to put a fixed condenser across the primary of the first audio transformer."

Those necessities were procured, the change was made and lo! and behold! it worked.

"Mel, dear!" exclaimed Dolly; "you're the cleverest boy!"

Superfluous words. He was no longer clever—he was now a full fledged expert.

Day by day Sobby perused the radio magazines and retained some of the things he read. Then he stumbled onto six articles, written by six different radio variometer engineers, and all knocked the tar out of reflexes. A reflex, the articles stated in no uncertain terms, was a collection of junk, transformers, wire and solder and fixed condensers that choked all the pep out of it and should only be used in the last stages of desperation, whatever that was supposed to mean.

Who was right? wondered Sobby. Taking unto himself a sheet of paper and a lead pencil, he began drawing

(Continued on Page 56)

For best results
in any Radio
Circuit use this

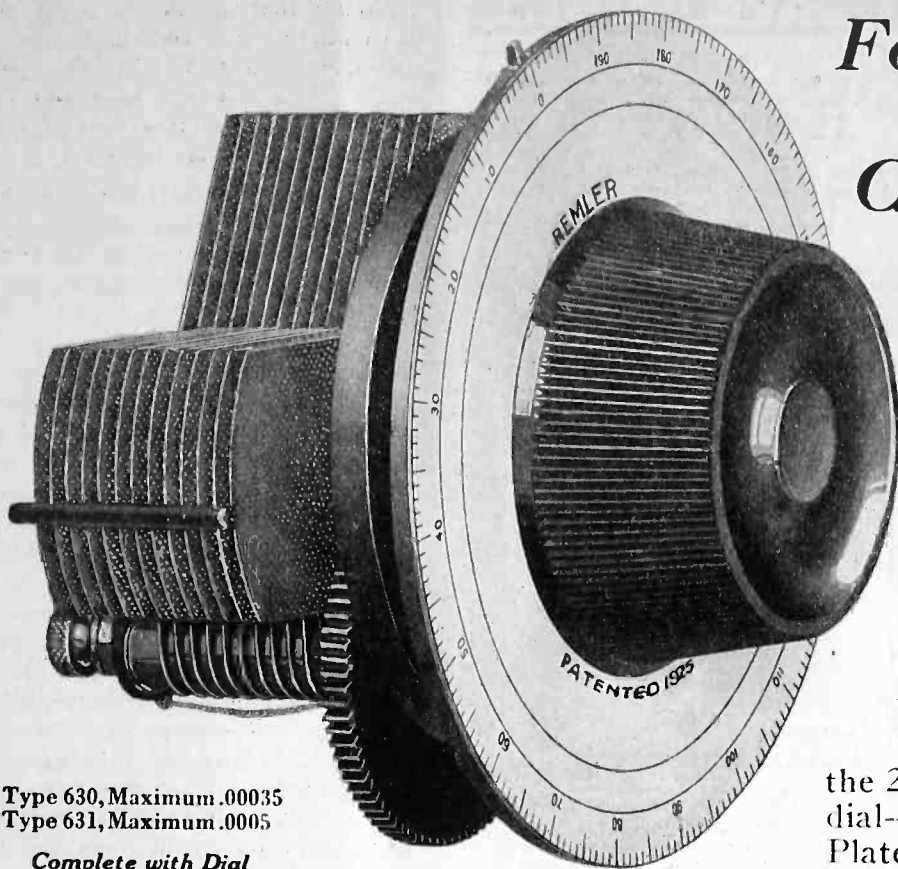

Type 630, Maximum .00035
Type 631, Maximum .0005

Complete with Dial

\$5.00

REMLER RADIO MFG. CO.
San Francisco - Chicago - New York

REMLER
TWIN-ROTOR
STRAIGHT-LINE
CONDENSER

IT IS an essential part of any circuit where the closest tuning is demanded.

A few of the "Reasons Why" are:

Thirty-five dial divisions cover the 200-300 meter range---Full 360° dial---Twin-Rotors---Embossed Plates---Straight line wavelengths.

New! Tone and Volume Control

ESSENTIAL to thoroughly enjoy present day broadcasting. New high-priced sets feature tone control as their greatest improvement. You can have this new feature in your old set by attaching a *Centralab Modulator Plug* in place of the old phone plug. Takes a moment—no tools required.

Gives any degree of tone volume from a whisper to maximum by simply turning the small knob on plug. Static interference is reduced and programs come in clear and true with just the volume you most enjoy.

Order from your dealer, or mailed direct on receipt of the price \$2.50.

CENTRAL RADIO LABORATORIES
14 Keefe Ave. Milwaukee, Wisconsin

Centralab Radiosms or Modulators are standard controls on sixty-six well-known sets.



Hoyt Pocket Meters

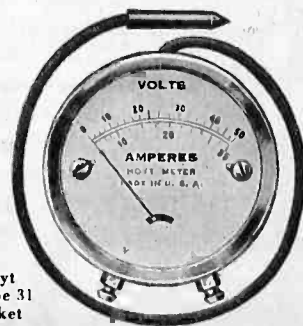

Hoyt
Type 31
Pocket
Meter

The indispensable pocket instrument for Dealers and Radio-Owners for checking the condition of A and B batteries. Reads up to 50 volts or 35 amperes. All scales are *hand-calibrated*, resistance of meter is unusually high for this type, accuracy does not vary in extreme heat or cold. Finished in polished nickel, of small size, convenient for handling.

Price, Complete With Lead,
\$3.00

BURTON-ROGERS CO.
26 Brighton Ave., Boston, Mass.
National Distributors

HOYT makes a complete line of Radio Meters. Send for booklet, "HOYT Meters for Radio."

New Radio Log Book and

AIR LINE DISTANCE MAP
50c Money Refunded if you
are not satisfied.
"RADIO," San Francisco

Centralab

CRL



Addressed to
Forward Thinking
 But
Skeptical Set Manufacturers:

GENTLEMEN:

It is true that to sell your sets this coming season you must build in a real B-Eliminator. Where is there one? You ask.

We can furnish you with the most important parts—Transformers and Chokes, Unmounted—and show you how to build your own B-Eliminators.

Dongan has built transformers for 15 years. Our products are endorsed by the manufacturer of Raytheon Tubes and the laboratories of the prominent radio publications. Our reputation is high—and precious.

Sincerely,



Transformers Fans---

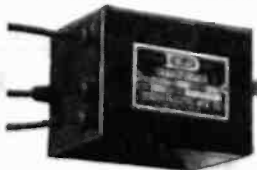

No. 509—Full Wave
 \$7.00 List

Also Transformers and Chokes for R. C. A. and Cunningham Tubes.

Chokes

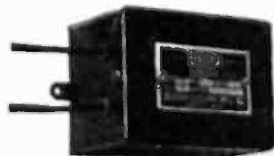

No. 514—20 Henry
 \$5.00 List

Raytheon Tubes
 \$6.00 List

Build Your Own With Dongan B-Power Units.

Very simple to construct from our diagram; and inexpensive, too. When you get through you'll find new pleasure in a radio free from hum, free of batteries that seem always to need replacing, etc. You will have for the first time—consistent performance.

If your dealer cannot supply you, send money order direct.

Dongan Electric Manufacturing Co.

2981-3001 Franklin St., Detroit, Mich.

Pacific Coast Representatives:

- San Francisco—Industrial Sales Co., 17 1/2 Second St.
- Los Angeles—W. A. Breuninger, 443 So. San Pedro Street
- Portland, Ore.—C. E. Coy, 166 Lewisdale Street
- Seattle, Wash.—E. P. Denhart, 2726 45th Avenue S. W.

TRANSFORMERS of MERIT for FIFTEEN YEARS

SAVE MONEY

RADIO GUIDE FREE

NEW 1926 RADIO GUIDE!

Hot off the press—brimful of new ideas, special hook-ups with information—all free. Shows savings as high as 50% on sets and supplies. Be sure to get this thrifty illustrated book before you buy. It means money in your pocket. Standard guaranteed goods. Write letter or postal note. Also please include name of radio friend.

BARAWIK CO., 102-124 S. Canal St., Chicago, U. S. A.

AMPLION
 For Better Radio Reproduction

Hear this World-Wide Favorite

Creation of Alfred Graham & Co., England, 38 years experienced in producing loud speaking devices, Amplions lead in sales throughout the world. Hear an Amplion—in comparison! Six models, including photograph units, equipped with cords and plugs, \$12 up. Write for "Amplion Pedigree."

THE AMPLION CORPORATION OF AMERICA
 Suite O, 280 Madison Avenue, New York
 Chicago Branch: 27-29 No. Morgan St.
 Bureau of Canada, Ltd., Toronto

Proved by Performance!



TRF Kit
 \$12.00

AERO COILS

This season—thousands more fans found the answer to complete radio satisfaction thru Aero Coils.

Selectivity! Distance! Power! All these—to a degree not yet even approached by any other inductances. And simply because the Aero Coil is patented—both in principle and in construction. Any set—any circuit is greatly improved by substituting these wonder inductances for those you are now using. At your dealers. Write for free Aero Booklet!

- CT-80—Thres Circuit Tuner (Variable Primary) \$ 8.00
- TRF-110—Radio Frequency Regenerative Kit 11.00
- WT-40—Wave Trap Coil 4.00
- OS-55—Oscillator 5.50
- AX-45—Antenna Coupler (Variable Primary) 4.50

AERO PRODUCTS, Inc.
 1768-1772 Wilson Ave., Dept. 13, Chicago

ARE YOU A SUBSCRIBER?
 SEND FOR TRIAL SUBSCRIPTION
 \$1.00 FOR SIX MONTHS

(Continued from Page 54)

paper circuits that should work, and the more circuits he drew, the bigger the expert he imagined himself. Strolling into John's shop one day, he found another salesman in there, demonstrating a new set with only three dials to tune.

This was a whistle-less radio set and it piqued Sobby's curiosity.

"Tuned radio frequency," the salesman replied to Sobby's question.

"Those're the babies," said Sobby. "I can improve on that set ya got there. What d'ya want for it? I'll buy it."

The transaction was made and the salesman gave Sobby a word of advice.

"Don't try to improve on it," he said. "It can't be done. Leave it alone and you'll get a lot of fun out of it."

"I know what to do," retorted Sobby. "I know these things backwards."

"Go ahead," said the salesman. "It's your instrument. I got your money."

The set was installed in a corner of the kitchen and worked beautifully. The local stations—sixteen of them—popped in and out without a hangover from their neighbors. But distance—not a peep. Had he turned his dials slower, he would have found them, but he was a dial twirler.

Talking to another variometer engineer the next day, and for the benefit of the uninitiated, a variometer engineer is a variometer engineer—one of those jejune individuals that refuse to learn any more—this mechanic essayed to enlighten him regarding the lack of distance.

"Ya got one o' those neutralized things. Them things ain't no good. Jest as soon as ya neutralize a set, ya take all the sensivity"—he meant sensitivity—"out of it. Take the neutralizers out, or, better yet, get a superhet. You know what Leo Kruger said: 'A neut's a neut, my son, but a superhet, she's a set.' Them're the babies."

So Sobby separated the set from its neutralizers. Forthwith, the set developed whistle-itis. That's a disease of radio sets and can only be cured with an ax or fire.

Then Sobby started to improve on the set. He tore out the coils—the radio frequency transformers—tore the wire from them and began rewinding them. Every variometer engineer gets to the re-winding stage. He substituted spider-web coils, with the primary in the middle. Dolly watched him wind.

"I'll wind one, Mel, dear," she said. Dear little helpmeet.

"All right. Wind thirty turns, under two pegs and over two pegs—see? Then stop and wind six turns of white and then stop—see? Then wind thirty more turns of the green wire—see?"

To every "see" she responded or appended a "yeah." Whether her "yeahs" were questions or statements was hard to tell. Then she began winding. By the time she wound five turns, she lost

(Continued on Page 58)

RADIO 'RITHMETIC

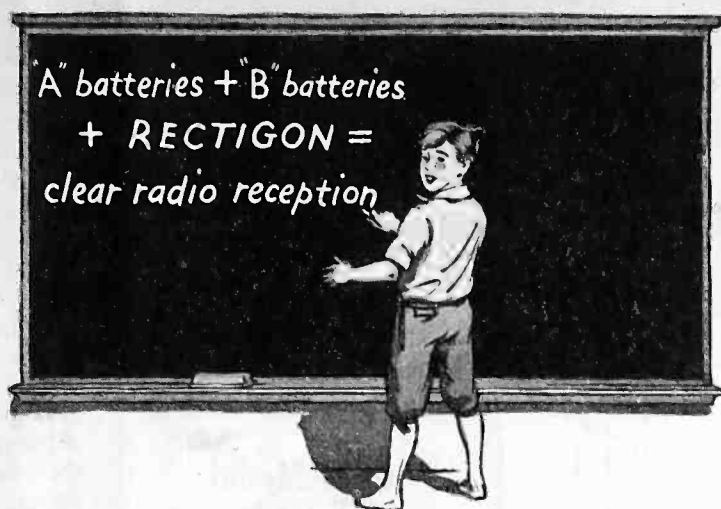

Multiply distance by adding a *RECTIGON*

A SIMPLE solution for so big a result! Want band music? Try KDKA. Jazz? Theatricals? Maybe you'll find it at WBZ, KYW or KFKX. What your local stations won't provide can be obtained easily from somewhere else.

How well you receive radio entertainment depends upon the condition of your batteries —and that's up to you. With a Westinghouse

Rectigon on the job both your "A" and "B" batteries can be kept fully alive to the greatest possibilities of your set.

And it's easy as can be. Just snap on the leads and turn on the current. There's no muss or fuss; no acids; no chemicals, and no noise. The Rectigon more than pays for itself within a short time.

WESTINGHOUSE ELECTRIC & MANUFACTURING COMPANY

SOUTH BEND, INDIANA

The Westinghouse Rectigon Battery Charger



© 1926,
W. E. & M. Co.

No storage-battery
radio is complete
without a
RECTIGON.

Westinghouse manufactures, also, a complete line of Micarta radio panels, Micarta tubes and instruments.

Tell them that you saw it in RADIO

ELECTRAD



LAMP SOCKET ANTENNA

Just plug in and get clear, loud reception instantly.

Minimizes Static and Interference Ends Summer Worries

Here is the quick, easy way to good summer reception—the

ELECTRAD

Lamp Socket Antenna

Just screw it into any lamp socket in the house, and you have loud, clear reception, with a minimum of static and of interference from neighboring sets. The Electrad Lamp Socket Antenna helps you get distance. It does away with all lightning worry. Uses no current. No danger. Every one tested and certified electrically. U. S. Price, 75c.; Canada, \$1.10; at good radio stores and counters. For safety's sake insist on Electrad.

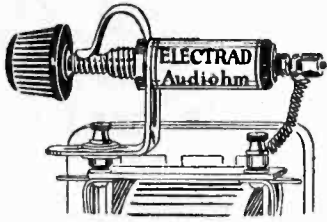

For Clearer, Purer Reception Do This:

Place an Electrad Audiohm across the secondary of your audio-transformer. Then you will enjoy your radio. Kills distortion, eliminates squeals and howls. Fits all audio-transformers. Easy to attach. For sale at all good radio stores and counters, U. S. \$1.50, Canada \$2.10.

For perfect control of tone and volume use the Electrad 500,000 ohm compensator.

For free hookup write 428 Broadway.

ELECTRAD

New York City *Inc.*

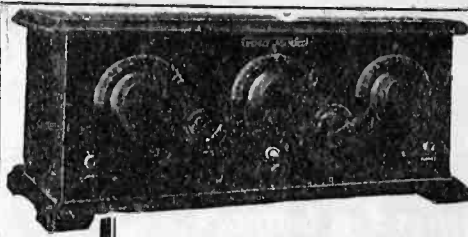

In
7x18"
Cabinet

It's a 5-Tube

Gold Medal Tuned Radio Frequency Receiver

Was \$60
without accessories

NOW \$25

without accessories

Agents write for proposition

Satisfaction Guaranteed

Delivered free anywhere
in the United States

Gold Medal Radio
1048 Longwood Avenue
New York City

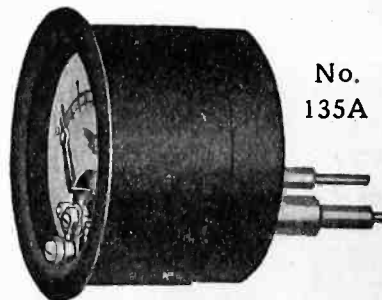

No.
135A

Send for

New No. 739 circular describing special voltmeters for Radiola, Victor and Brunswick sets.

Order from dealer

**Jewell Electrical Instrument
Company**

1650 Walnut Street, Chicago
26 years making good instruments.

(Continued from Page 56)

count. Oh, well—what's five or nine turns of wire, more or less, especially between man and wife? She could count to six, so she got the white wire on all right. Back to the green. When she counted sixty on the green, she really had seventy five, but no matter.

The coils were wound and replaced in the set. Then followed days of taking off wire and putting on wire. The place was full of wires, of every color and gauge. Finally, the three condensers would almost line up together.

One morning the telephone rang. It was John.

"I got in some o' those alternating current tubes," he informed Sobby. "Ya don't need no storage battery. Take your juice through a transformer from the 'lectric light socket. If ya want volume an' distance, them're the babies."

"I'll be right over," replied Sobby.

He came back home with five of the new fangled tubes. Some minor changes were made in the set and the tubes installed. They burned green. The set made lost of noise and the tubes looked pretty.

"Oh, Mel, you're the cleverest boy!" exclaimed Dolly.

Telling this strabismic sphere, Marconi was a mere beginner.

The next night Sobby met another variometer engineer, to whom he related the wonderful performance of the green-burning tubes.

"Yeah," conceded the variometer engineer; "they're good, but, if ya wanna get the most outa them, reflex 'em an' ya won't need more'n twenty-two volts o' B battery on the plate. If ya want volume an' distance, them're the babies. I got one, an' I get coast-ta-coast on three tubes every night an' I get so much volume it busts the windas. Try a reflex with 'em, kid, an' ya got somethin'."

The next day Sobby sat down with paper and pencil and drew a theoretical circuit. On paper it looked immense. Taking another look at it, it look "immenser."

Out came the old reflex panel and Sobby got under way, under full steam. This was going to be "something." He took a week off from jazz breaks to put it together. When he got through with this set, he could throw the sobbing calabash into the garbage can—he'd be a famous man. But, he didn't count on Dolly.

Dolly, "sweet liddle sugar dahl'ink," she bragged all over the neighborhood how her clever Mel was building the set that was going to make all the radio experts look like a flock of white wings. People came into the house at all hours of the day, to see clever Mel build the set. Slowly and painstakingly he worked at it. Somewhere he had read, "Keep your plate and grid leads at right angles to each other and as far apart as possible and keep your leads

short." That line has as much punch to it as how short is short or how many hairs in a brush? The man that invented that line should be perpetuated in the same marble from which his head is composed. Sobby measured those plate and grid leads with a ruler that had the inches divided into hundredths. If he made the leads short, he couldn't keep them at right angles and far apart.

However, after much calculation, he finally got them placed where he thought they would be short, at right angles and far apart. But, they never are.

The evening of the third day of labor the last wire was soldered and the set was ready to function—mebbe. All of Dolly's relations and some of Sobby's and a multitude of neighbors came in to hear the great radio set that was going to revolutionize the radio industry.

Sobby was hooking wires to the set. "Can I help you, dear?" inquired Dolly.

"Sure, Doll," said Sobby; "hook up the B battery."

In all the excitement Sobby forgot that the variometer engineer had told him to use only 22 volts of B battery. Under the table sat two 45 volt blocks. Dolly hooked the two blocks together, making a total, in easy arithmetic, of 90 volts.

Sobby had an extension cord about 30 ft. long attached to the loud speaker, so he could move it around the house. He coiled the cord on the floor and stood the speaker on top of the radio cabinet. He shoved the plug into the jack and turned on the set. Twirling the two dials, from the speaker came a loud hum, like a vast bee hive at work. Then he hit the wavelength of the nearest broadcasting station right on the head. The loud speaker, like a thing animate, leaped six feet into the air, everybody fell off their chairs and the speaker continued to leap and bound around the room.

The piano accompaniment coming through the horn sounded like fifteen brass bands blasting fortissimo, and a mighty voice was bellowing, "Oh, you, ukelilly ludy, ukelilly ludy lu; if you wanna a ukelilly ludy—"

Into the bedroom bounded the loud speaker, bellowing "Ukelilly ludy" and accompanied by a brass band. Everybody gave chase. It leaped and bounded back into the kitchen, upon the stove, down to the floor, into the bathroom, out again, hit the dining room ceiling and crashed to the floor. Sobby had turned off the power.

The company looked at each other aghast. What kind of a devil was this? Dolly, with screw driver in her hand, walked to the receiver, replaced the loud speaker on the table and opened the cabinet.

"I know what's the matter," she told Sobby. "You should ought to put a fixed condenser across this reflex audio

NOW THE FACTORY-BUILT BREMER-TULLY COUNTERPHASE SIX

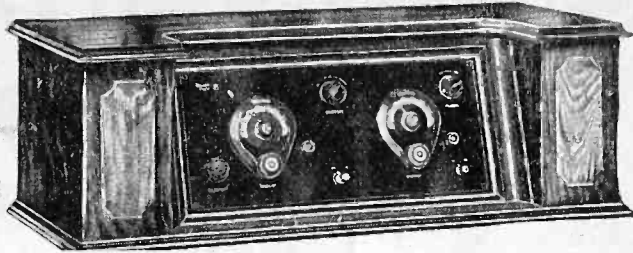

\$165.00

\$175.00
West of the
Rockies

EXCELS IN EVERY FEATURE

Selective, Range, Volume and Tone. A combination of the finest parts ever used in a factory-built set. The ideal set for Summer or Winter reception.

"—EVERYTHING THAT ONE COULD DESIRE IN A RADIO SET—." Says the radio editor of the San Francisco News Letter.

Increased production enables us to supply more and more high-grade dealers with the Counterphase Six. If your dealer cannot give you a demonstration, ask him to write us.

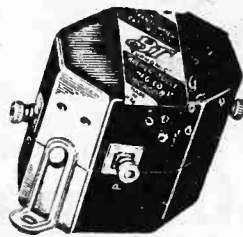

2.2 to 1.....\$5.00
4.7 to 1.....5.75

FOR REAL TONE QUALITY

You can do no better than choose B-T Euphonic Audio Transformers. They amplify both high and low notes with equal clarity with sufficient volume for all needs. They are used in the factory-built Counterphase Six and are largely responsible for its excellent tone.

Try them on your set. The results will please you.

BETTER TUNING

The B-T booklet—68 pages of straight-to-the-point radio facts.
Sent postpaid on receipt of 10c in stamps or coin.

BREMER-TULLY MFG. CO.

532 So. Canal St., Chicago, Ill.

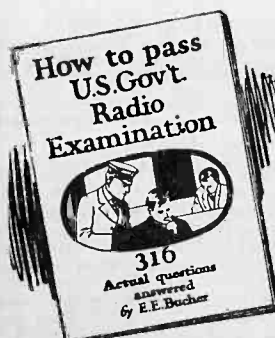

PASS the U. S. Government Commercial or Amateur Radio License examination! This book will help you do it! Send sixty cents in stamps or coin for your copy—postage prepaid to any point in the U. S., Canada or Mexico

For a Short Time Only **60c**

RADIO INSTITUTE OF AMERICA
322 Broadway, New York City



You Get Perfect Tone Quality With MURDOCK Headphones.

WM. J. MURDOCK CO.

211 South San Pedro St., Los Angeles;
509 Mission St., San Francisco; 406 Occidental St., Seattle, Wash.

MURDOCK RADIO

ARE YOU A SUBSCRIBER?
SEND FOR TRIAL SUBSCRIPTION
\$1.00 FOR SIX MONTHS

It's Easy to Build A Powerful Set

Using the New and Improved
FRESHMAN "TRF" Low Loss Kit



Straight Line Wave Length Condensers With Low Loss Self Balanced Coils

These are the identical units which have made the FRESHMAN MASTERPIECE factory built Receivers the World's Greatest Radio Sets

\$ 9.50

Complete instructions for building this powerful five tube receiver, written in plain everyday English, together with actual size schematic wiring diagram are furnished with every FRESHMAN "TRF" Kit.

Sold by Authorized Freshman Dealers Only!

CHAS. FRESHMAN CO., INC. Freshman Building, New York
2626 W. Washington Blvd., Chicago

and choke it down." She pushed the screwdriver down on the reflex audio in question. At the same time, she was toying—that's a good word—toying with the switch. The switch was of the "toggle" variety—just a slight pressure on the side sprung it either way. Sobby shoved his nose down over the reflex audio and she applied the slight pressure.

The loud speaker did another leap, the tubes blazed blue, the reflex audio blazed blue, the transformer between the set and the electric light socket blazed blue, a newspaper took fire and the lights went out.

Total silence.

Sobby stamped on the burning newspaper and wiped the sweat off his forehead.

"I guess you blew a fuse, Doll," said Sobby. If that was all she blew, everything was jake.

"I'll light a candle," responded Dolly. She did. Sobby took it out of her hand and started for the basement, to replace the blown fuse. The telephone bell rang. Sobby set the candle down and picked up the telephone.

"Six, oh, six, Jay," he snapped.

"Hello! Is this you, Sobby?" from the other end of the wire. "This is John. I got a shipment of those there new 'Green Bottle' tubes. If you wanna get volume an' distance, thos're the babies."

Sobby, breathing hard through his nose, gripped the telephone until the veins stood out on his hand.

"Listen!" he yelled. "If my wife wasn't standing here, I'd tell you to take your dog-gone 'Green Bottle' tubes and go—"

"I wouldn't go to your sister's house when you're there, you old crab!" snapped John, anticipating the rest of the sentence, and slammed the receiver on the hook.

And so radio lost another variometer engineer and an expert. Now he has a tailor made set and keeps his fingers out of it.

ARMY AMATEUR RADIO NETS

(Continued from Page 9)

teur Radio Station." A copy of this application should be mailed to the headquarters of the A.R.R.L. at Hartford, Connecticut.

The Signal Corps at the Presidio of San Francisco has recently installed a 500-watt, 500-cycle short-wave transmitter, which will be used to broadcast information relative to the operating of the Ninth Corps Area Amateur Nets on regular schedules.

The 16,000 licensed transmitting radio amateurs in the United States have a wonderful opportunity in this plan to handle a large amount of important official traffic, thereby fitting themselves to be of great assistance to their country in a profession for which they would be qualified in case of an emergency.

FREE RADIO GUIDE

NEW 1926 EDITION NOW READY! Full of newest ideas, latest hook-ups. Saves you as much as half on a set. Shows standard radio parts, kits, sets at big savings. Be sure to get this thrifty book before you buy. Also please include name of radio fan.
BARAWIK CO. 102-124 So. Canal St., CHICAGO, U. S. A.



NO MORE LOOSE CONNECTIONS X-L PUSH POSTS

A binding post that really does excel, looks, action, service, and convenience. Push it down—insert wire—cannot jar loose from vibration. No screwing or danger of shearing off wires. Furnished attractively plated with soldering lug and necessary markings. Price, Each 15c.
X-L RADIO LABORATORIES
2428 Lincoln Avenue Chicago

ARE YOU A SUBSCRIBER?

CALLS HEARD

(Continued from Page 39)

By 6RO, James E. Randolph, 284 4th St., San Francisco, Calif.

40 meters. 2hv, 2ku, 2nz, 2aof, 3aab, 3adz, (5afb), 5agu, 5ahp, 5ahr, 5ain, 5akl, 5asg, 5atv, 5jd, (5pl), 5rk, 5vl, 5se, 6aba, 6asf, 6apw, 6bhz, 6bis, 6bln, 6bol, 6cbp, 6ccv, 6crr, 6cuv, 6cyp, 6clp, 6dah, 6dan, 6rm, 7akv, 7cs, 7ez, 7ip, 7ly, 7no, 7sf, 8afu, 8if, 8bit, 9aau, 9ahf, 9anz, 9ccv, 9cfx, 9evn, 9bmk, 9bmt, 9ode, 9ddh, 9dge, 9doq, 9eak, 9pn, 9ul, 9sf, 9xi, 9zt, kio, wir, wiz, nbm?

By 9BQE, 2515 So. Harrison, Fort Wayne, Ind.

1bad, 2cxy, 3ahp, 4av, 5uk, 6az, 6bx, 6cc, 6cn, 6ct, 6df, 6dn, 6ea, 6eb, 6ec, 6eq, 6es, 6ew, 6fa, 6hm, 6il, 6jl, 6jy, 6kb, 6kg, 6lr, 6lv, 6no, 6nw, 6nx, 6oi, 6oj, 6om, 6pr, 6rf, (6si), 6sz, 6tg, 6uc, 6ue, 6uo, 6ut, 6vr, 6yd, 6zr, 6aai, 6aak, 6aar, 6abg, 6abr, (6adw), 6ael, (6ajj), 6ajl, 6ajm, 6akm, 6akt, 6akw, 6akx, 6ann, 6ano, 6aps, 6are, 6asd, 6ase, 6asm, 6asu, 6atu, 6auf, 6aut, 6auu, 6auy, 6bav, 6bcl, 6bcs, 6bek, 6bgc, 6bgm, 6bhj, 6bhz, 6bid, 6bil, (6bjv), 6bjx, 6bkb, (6bls), 6bol, 6boo, 6bov, 6bqc, 6bql, 6bqr, 6bsf, 6bsc, 6bsh, 6bt1, 6btm, 6bur, 6bve, 6bvh, 6cah, 6cax, 6cbb, 6cbf, 6cco, 6cdw, 6cez, 6cfe, 6chl, 6cia, 6cii, 6cin, 6cix, 6cnh, 6cou, 6cqa, 6cqe, 6cra, 6crs, 6css, 6ctd, 6cto, 6cur, 6cvk, 6cwr, 6daa, 6dab, 6dag, (6dai), 6daq, 6das, 6dax, (6dbe), 6djb, 6dis, 6dtm, 6dux, 6dvl, 6xad, 6xaf, 6xaw, 7al, 7am, 7ay, 7ek, 7fj, 7fm, 7fw, 7gb, 7hb, 7hd, 7ki, 7lq, 7mz, 7no, 7nq, 7pj, 7ps, 7pu, 7rl, 7tm, 7ux, 7vb, 7wu, 7ya, 7abf, 7adq, 7aek, 7aif, 7aip, 8ry, 9abi. Canadian: 1am, 1ed, 2cn, 3aa, 4fv, 5ag, 5an, 5ef, (5hp). Mexican: 1a, 1b, 1k, 1x, 1aa, 1af, 9a, bx, hu, 6aff, 6bub, 6buc, 6dbl. Naval: (naw), (ncc), npg, npm, npu, nis, nirv, nism, nisp, nisq, nisv, niwv, nosn, nosm, kgqz, nkf, wqo. Miscellaneous: q2lc, (2jt). Italian: lau, lmt, pr-4sa, a-gdbv, pof, fw, lpz, zam, 6zac, ber, (fra). All cards answered. Qrk? 9bqe.

By F. M. Larand

Heard by F. M. Larand between Timor and Mauritius Islands from Nov. 1st to Nov. 30. 40 meters band.

American: 1aao, 1al, 1axa, 1ch, 1ck, 1rd, 1yc, 2agg, 2xu, 3auv, 3brh, 3jo, 4bu, 4io, 4oa, 4tv, 5aau, 5ahp, 5ce, 5eh, 5nw, 5que, 5sy, 6asr, 6awt, 6bdg, 6bix, 6bse, 6chz, 6bjd, 6bg, 6buc, 6chl, 6clu, 6cmh, 6cn, 6cnd, 6gg, 6hm, 6js, 6vc, 6wa, 6zac, 7fuj, 8brc, 9caj, 9cfy, 9evl, 9del, 9dng, 9dvl, 9hp, 9lc, 9zt. Australian: 2aq, 2cs, 2rj, 2ui, 2vi, 3ad, 3ak, 3ao, 3jp, 3kb, 3lm, 3lp, 3xo, 5ww, 7dx, 7pf. New Zealand: 2ac, 4av. American Naval: najd, najl, neqg, nkf, npn, npo, npp, npu, nuqg, nqgl, nsx. Philippine Islands: 1ar, 1au, 1cw, 1hr. French: 8az, 8lbt. Brazilian: 1al, 1ap. Argentine: cbh. South Africa: a3e. Miscellaneous: aga, ane, anf, age, gha, gfup, pell, pemm, pow, ocdj, rau, rrp, wiz, wgo, vit, wup. Unknown: fb, li, fx1, fml, fiv, uu, fce.

SHORT WAVES

(Continued from Page 30)

good ground connection can be made to use a counterpoise of about two-thirds the length of the antenna in about the same general direction.

The main secret in all this short wave business is to have a tuner that does not cramp the signals, employ good vernier control for the tuning condenser, and use the largest number of turns in the grid circuit to cover the wave band required. Only in this way can the inductance capacity ratio be kept low and loud signals heard. It would be well to employ a low internal capacity tube so that the capacity of the circuit is kept low. One stage audio frequency amplification should enable daylight reception of radiocasting in the East of stations using high power such as mentioned, with ease. Possibly the best part of this short wave business is that "dx" is easy to receive, daylight range extended, and the interference is practically nil. One can see that to get best results is to just employ the same methods as are used in the usual radiocast work. Surely this

CORBETT CABINET for BEST'S SUPERHETERODYNE

A specially designed and constructed cabinet for the new super by Best.
Takes 10x20 panel.

With piano hinge, slots and drillings to specifications
Sloping panel cabinet (1 1/2" slope) for added beauty

American Walnut.....	\$16.00
Mahogany	\$16.00
Mahogany or Walnut Finish.....	\$13.50

NEW MODEL "T" CABINET



Size	Mahogany		Size	Mahogany	
	Finish	or Walnut		Finish	or Walnut
7x18-8	\$8.55	\$9.50	7x18-10	\$10.20	\$11.55
x21-8	9.30	11.50	7x21-10	10.90	13.25
7x24-8	10.10	12.60	7x24-10	11.70	14.65
7x26-8	10.70	13.35	7x26-10	12.65	15.80
x28-8	11.80	14.70	7x28-10	13.00	16.20
7x30-8	12.75	15.85	7x30-10	13.30	16.65

"CORBETT'S CABINETS" have been preferred for several years by quality set builders and are unquestionably superior in design and finish. They are backed by our guarantee to please you. Carefully hand-rubbed piano finish. Well packed for shipment.

Express Charges Prepaid in U. S. A. and Canada

Corbett Cabinet Manufacturing Company

ST. MARYS, PENNSYLVANIA

WRITE FOR CATALOG showing attractive models for all sizes of radio cabinets, consoles and tables.
Jobbers and Dealers write for discounts.

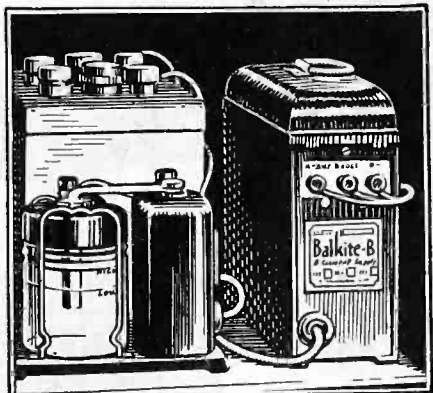

CONVERT your present radio receiver into a light socket set with a Balkite Trickle Charger and Balkite "B"

Balkite Trickle Charger, \$10.50. Balkite "B," \$35. At your dealer's.

Manufactured by FANSTEEL PRODUCTS COMPANY, Inc., North Chicago, Illinois

RADIO AGENTS WANTED

5 Tube Demonstrator FREE!

Famous Air King line of 5-Tube T. R. F. Receivers. 3 models, retail for only \$49.50 to \$59.50. Solid walnut cabinets. Wonderful tone and power. Liberal discounts to user agents. Write today. 20TH CENTURY RADIO CO., 1012 Coca Cola Bldg., Kansas City, Mo.

RADIO from Factory to YOU

Get our list price on Parts also
Knocked Down 1 and 3 Tube Sets
Compare List Price with others then
Deduct 20 to 50 per Cent Your Price
A. C. HAYDEN CO., Brockton, Mass.



\$1.00

CARTER

New All Metal "IMP" Rheostat

No moulded parts to break or crack. Special Carter designed contact arm noiseless, smooth. Guaranteed to work satisfactorily in any circuit.

All resistances 3 to 50 ohms

Coast Distributors: A. S. Lindstrom & Co., 274 Brannan St., San Francisco, Calif. Branch Offices: Los Angeles, Portland, Seattle, Salt Lake City. In Canada: Carter Radio Co., Limited, Toronto.

Carter Radio Co.
300 S. PULASKI AVENUE
CHICAGO, ILL., U.S.A.

Tell them that you saw it in RADIO

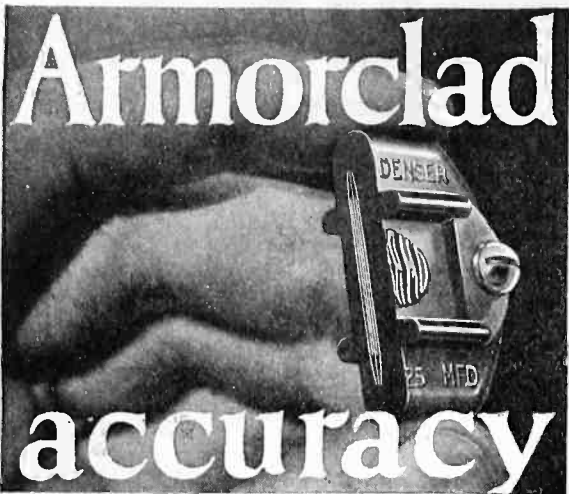

BE careful when choosing fixed condensers, if you want supreme results in radio. Look for permanent accuracy. These little valves must measure with perfect precision. If too much or too little energy is released at one time, the rest of the circuit chokes or starves.

SANGAMO Mica Condensers

are accurate—and they stay accurate forever, being molded in an armor of bakelite that gives complete protection against heat, cold, moisture, corrosive fumes, or accidental contacts with tools. Not a crevice in the armor into which moisture can creep, for the accuracy of a condenser can be utterly ruined by dampness absorbed from the atmosphere.

The sustained accuracy of Sangamo Condensers makes an immense difference in the tone, range, volume and selectivity of any well-built receiver. There is no finer looking or more accurate condenser on the market—that's why Sangamos are used by so many professional builders of radio sets.



Approved by all nationally recognized radio laboratories

SANGAMO BY-PASS CONDENSERS
Surges won't break them down. Sizes to meet your requirements.

Sangamo Electric Company
Springfield, Illinois

RADIO DIVISION, 50 Church Street, New York

SALES OFFICES—PRINCIPAL CITIES

For Canada—Sangamo Electric Co. of Canada, Ltd., Toronto.
For Europe—British Sangamo Co., Ponders End, Middlesex, Eng.
For Far East—Ashida Engineering Co., Osaka, Japan



MYERS



Seven Years of Superiority

KNOwn as the original HI-MU tubes before the days of BCL;

Preferred by amateurs and experts before the first popular receiving set was sold;

Progressively improved in construction and performance;

Made in the newest and best equipped plant in America.

Get the World on Your Dial With Myers Tubes

Low impedance, high amplification constant, high mutual conductance. Best results in any circuit—impedance, resistance or transformer coupled.

At Your Dealer's

Myers Radio Tube Corporation
Cleveland, Ohio

Attractive, compact, correct inside and out, no clumsy materials. Made by pioneer designers and builders of Radio Tubes.

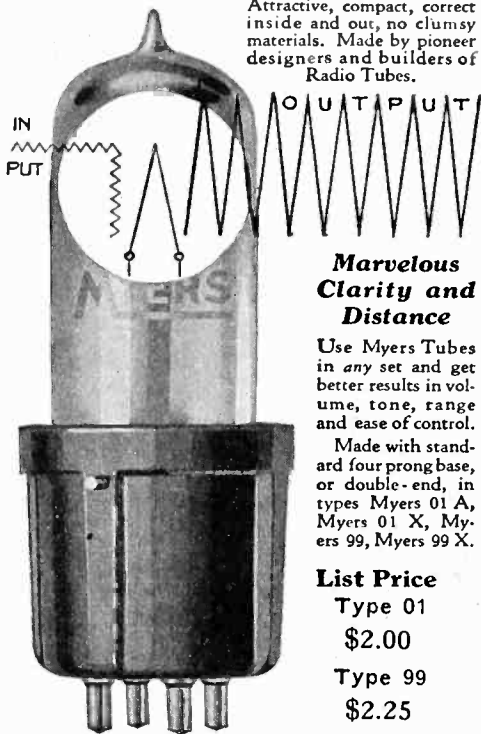

Marvelous Clarity and Distance

Use Myers Tubes in any set and get better results in volume, tone, range and ease of control.

Made with standard four prong base, or double-end, in types Myers 01 A, Myers 01 X, Myers 99, Myers 99 X.

List Price

Type 01

\$2.00

Type 99

\$2.25

then is easy. Reception of harmonics of local stations is also possible. Sometimes the harmonics are very strong and might cause trouble but this is rare indeed. With the new short wave tuners on the market maybe some refinements may be made as here given and thereby increase their efficiency.

DESIGN OF LOW PASS FILTERS

(Continued from Page 33)

When the Heising system of modulation is used, certain restrictions are placed on the filter construction. It has been shown that large capacities are required for completely filtering disturbances over all frequencies above a certain pre-selected cut-off frequency. The success of the Heising system of modulation depends upon the storage tank effect of the audio choke coil in the positive generator lead to the plates of the tubes. The effect of capacities as large as those required for complete filtering at all frequencies would be to lower the impedance in the plate circuit below that which is demanded. In this case an ideal filter must be sacrificed in favor of an arrangement designed with the above limitation in mind. The solution of this problem resolves itself merely into constructing a trap circuit

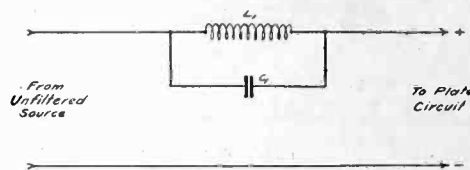

Fig. 7. Trap Circuit.

of the type shown in Fig. 7 wherein the ratio of inductance to capacity is as large as practical limitations permit and the circuit is resonant to the most disturbing frequency. If this frequency is 120, which will usually be found to be the case when rectification of 60 cycle alternating current is had, a 100 henry choke shunted with a capacity of 0.0175 microfarad is recommended. Certainly no less than 50 henries inductance should be used as the capacity for resonance in this case is 0.035 microfarad. In general, a capacity no larger than 0.02 microfarad should be used. Should the most disturbing frequency be other than 120 cycles, the correct value of capacity and inductance for resonance may be determined from the relation,

$$f = \frac{1}{2\pi\sqrt{LC}}$$

where,

f —the disturbing frequency.

L —inductance in henries

C —capacity in farads, and this should be no greater than 0.0000002 farad.

Attention is called to the author's article in February RADIO for constructional data on large choke coils as well as capacities for this purpose.

You Can Get

Greater Reflex or Crystal Set Reception if you use the

BROWNLIE

Vernier Detector

\$2.00 at Your Dealer or Direct

ROLAND BROWNLIE & CO.,
22 Saunders St. Medford, Mass.



ADDITIONAL COPIES

—of—

THIS ISSUE OF "RADIO" CAN BE PURCHASED FOR 25c FROM THE PUBLISHER.



Oh boy
KESTER
 Rosin Core
Radio SOLDER
 Sure is Safe and Simple

Approved by
Radio Engineers
 A Genuine Solder
CHICAGO SOLDER COMPANY
 4254 Wrightwood Ave., Chicago, U.S.A.

*Originators and
 World's Largest Manufacturers of
 Self Fluxing Solder
 YOUR DEALER
 CAN SUPPLY YOU*



DON'T WAIT!
 Pep Up That Set Now With
X-L VARIO CONDENSERS
*Install them in your receiver and hear them
 speak for themselves*
 SPECIFIED BY
GERALD M. BEST
 Endorsed and Used by the Foremost
 Radio Engineers

SPECIAL FOR MODIFIED 45,000 CYCLE SUPERHETERODYNE
 CAP. RANGE .00002 to .0001 M. F., \$1.50
MODEL N—Capacity range 1.8 to 20 micro-microfarads for balance in Roberts two tube, Browning-Drake, McMurdo Silver's Knockout, Neutrodyne and tuned radio frequency circuits. Price, \$1.00.
MODEL C—Two capacity ranges, .00016 to .00055 and .0003 to .001 Microfarads, for the Cockaday circuit, filter and intermediate frequency tuning in superheterodyne and positive grid bias in all sets. Price, \$1.50.

X-L RADIO LABORATORIES
 2426 Lincoln Avenue CHICAGO

LINK YOUR SUPER
 to an **OUTDOOR AERIAL!**
 INCREASE YOUR RANGE AND VOLUME!
 IMPROVE THE SELECTIVITY!
Write today for full information

The Superadio Co. NEW YORK CITY
 136 LIBERTY ST.



Place Speaker Anywhere

BRACH Extension
 Cord Connectors

ARE YOU A SUBSCRIBER?
 SEND FOR TRIAL SUBSCRIPTION
 \$1.00 FOR SIX MONTHS

RADIOADS

A Classified Advertising Section Read by Better Buyers.

The rate per word is eight cents net. Remittance must accompany all advertisements. Include name and address when counting words.

Ads for the May Issue Must Reach Us by April Fifth

WESTERN ELECTRIC power amplifier on Formica panel with additional stage impedance audio, anti-capacity switch for inter-stage switching, two gain controls. Fine for cones, a bargain at \$45 with three power tubes and one Daven 20-mu. Also Raytheon "B" eliminator, 150 volts, no hum, \$30 complete. Three Silver-Marshall matched intermediates No. 210 with 211 filter, \$12.50. 48 volts Willard 2500 milliamp-hour "B" batts, \$6.50. 1843 North Alexandria, Hollywood, Calif.

FOR SALE—9-TUBE HAYNES DELUXE SUPERHETERODYNE, complete with set of matched tubes, exactly as described in February and JULY, 1925, RADIO. First offer of \$100 takes it. Terms, C. O. D. E. C. Milly, 1534 Newcomb Ave., San Francisco, Calif.

A Lifetime Edison will solve your "B" battery troubles. Good live, large-size elements connected with pure nickel wire, electrically welded at 7c pair. Separators 1/2c. All parts for sale. Sample cell and dope sheet 10c. Paul Mills, Woodburn, Oregon.

SUPER-DX on my famous selective 1-tube circuit. Data 50c, Thurman, 3675 Madrone, Oakland.

BE A DETECTIVE—Earn Big Money; fine work; great demand; cities, towns, traveling; we show you; particulars free: write Captain Wagner, 188 East 79th Street, New York. (31)

ANTI-CAPACITY COIL CEMENT 35c bottle. Witteck Radio, 2769 Lincoln Ave., Chicago.

\$50.00 WEEK. Mail order business. Free booklet tells how. Sample and plans 25c. W. Pugh, 902C West 61, Seattle, Wash.

"A" BATTERIES ELIMINATED on Reflex with Blax, \$1. Ernest Koskey, 3535 Graceland, Indianapolis.

THE NEW square plate Ensign Variable Condensers. JUST OUT! Brass plates. Efficient on low waves. Get one of these condensers without cost in return for your subscription to "RADIO" for only two years. Five dollars brings you the condenser and the magazine. Send your check now. There are only a few of these condensers in our stock. "RADIO," Pacific Building, San Francisco.

FUNNY RADIO STORIES. Twelve of 'em in the "RADIOBUSTER," Volney G. Mathison's humorous thriller. 112 pages in bound form. Mathison knows how to write. You will enjoy his stories. Send \$1.00 today for a copy of the "RADIOBUSTER," or get it free with your subscription to "RADIO" for one year (\$2.50). Pacific Radio Publishing Co., Pacific Building, San Francisco.

YOUR RADIO QUESTIONS ANSWERED FREE.—Gerald M. Best, technical editor of "RADIO," will answer ten radio questions for you if you subscribe to "RADIO" for only one year at \$2.50. Get this wonderful technical service, together with a good, practical radio magazine. "RADIO," Pacific Bldg., San Francisco.

WANTED—More readers of "RADIO" to advertise their used equipment in these columns. RADIOADS bring quick and profitable sales. Turn your excess apparatus into profit. Some of our readers want just what you have to offer. Try the RADIOADS. You, too, will then be convinced that they PAY. Mail your copy now for the next issue.

KEEP station records in THE RADIO LOG BOOK, a handy pamphlet for recording stations heard, dial settings and other data. The price is only 10 cents per copy. For sale by Pacific Radio Pub. Co., Pacific Building, San Francisco.

A SUBSCRIPTION TO
 "RADIO"
 INSURES REGULAR
 RECEIPT OF COPY



Dealers:

A copy of this MONTHLY RADIO DEALERS' VALUE BOOK should be in your files. Compiled by experts, it is crammed full of the newest and latest in radio. Everything included and illustrated—parts for all standard circuits as well as the newest developed. You are assured of the same co-operation and service that we render dealers the country over.

READY--IMMEDIATE DELIVERY

MESSERS SILVERS & COCKADAY

New S-C 4-TUBE RECEIVER

Parts Used in the
 Silver-Cockaday Receiver

1 S-C Belden Wiring Harness; 1 Centralab Resistance, No. 25 M. S. R.; 1 Polymet .00015 condenser with grid leak clips; 1 Polymet .002 condenser; 1 Polymet .005 condenser; 1 2-megohm leak; 1 Drilled and Engraved Front Panel; 1 Drilled and Engraved Sub-panel; 2 Silver Marshall No. 316, .00035 Condensers; 2 Silver Marshall No. 515 Coil Sockets; 1 Silver Marshall No. 801 Vernier Dial; 1 Silver Marshall No. 110A Coil; 1 Silver Marshall No. 114A Coil; 4 Silver Marshall No. 510 Tube Sockets; 1 Silver Marshall No. 340 Condenser, .000025; 1 Silver Marshall No. 540 Mounting Brackets; 2 Thordarson Equipformers; 1 Yaxley No. 16K 6-ohms Rheostat; 1 Yaxley No. 1 Jack; 1 Yaxley No. 2 Jack; 1 Yaxley No. 10 Switch; 1 S-C Book of Instructions.

IMMEDIATE DELIVERY

COCKADAY'S RAYTHEON PLATE SUPPLY UNIT

List of parts with complete detailed information is yours free. Write for our newly issued catalog.

NEW! POWER UNIT

All parts in stock exactly as specified. Complete information, etc., sent on request.

We are wholesale distributors for these standard lines

Acme	Write for DISCOUNTS	Benjamin
Silver-Marshall		Precise
Hammarlund		Frost
All-American		Remler
Daven		Philco
Yaxley		Weston
Carter		Celatsito Wire
Raytheon Tubes		Victoreen Super
		Mar-Co

FREE A POSTAL BRINGS IT!
 Send for your copy now—TODAY. A postal brings our latest copy and puts you on the mailing list to receive it monthly.
 SEND FOR IT TODAY!

WHOLESALE RADIO SERVICE CO.

Manufacturers and Wholesale Distributors of
 Radio Parts, Appliances and Apparatus
 6 Church St. Dept. RA-426 - N. Y. C.

ONLY SHEER MERIT COULD WIN SUCH APPROVAL

Transmitting sets of such recognized radio experts as Lieut. Fred H. Schnell (A.R.R.L.) and Gerald M. Best, Technical Editor of RADIO, have been pictured in these advertisements.

The accompanying illustration shows the transmitting set of Don Wallace, (9ZT) winner of the Hoover Cup.

These experts use and endorse NATIONAL Transmitting Apparatus. Such a marked preference does not come by chance. Merit alone has raised NATIONAL radio products high in the esteem of these and other leading radio experts.



NATIONAL Transmitting Apparatus
Used by Don Wallace (9ZT)

FOR IMPROVING THE HOME-BUILT SET

These NATIONAL Radio Products Give the Utmost Satisfaction

NATIONAL Tuning Units Embodying the Genuine BROWNING-DRAKE TRANSFORMER

BD1-A
Patents pending

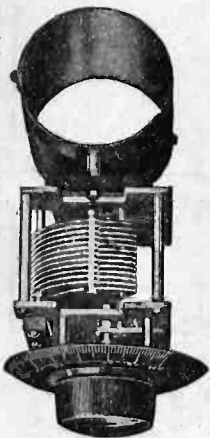

NATIONAL Tuning Unit BD1-A, comprising the BROWNING-DRAKE Inductance Coil and NATIONAL Condenser.

Price \$9.25

Also the
National
Equimeter
(Straight Line Wave Length)
CONDENSERS

and the

National
Velvet Vernier
DIALS

NATIONAL Tuning Units are standard — their efficiency proved.

Send for Bulletin 106R

Each unit is packed in an individual carton

BD2-A
Patents pending

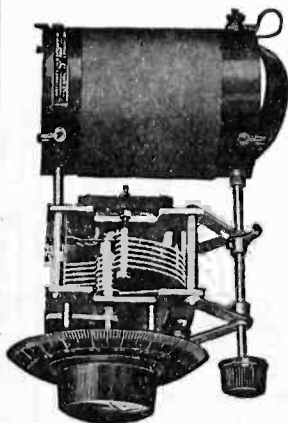

NATIONAL Tuning Unit BD2-A, comprising genuine BROWNING-DRAKE Transformer and NATIONAL condenser.

Price \$12.75



Price \$2.50

Send for Bulletin 109R

Type B, Variable, Velvet Vernier DIALS

(Patents pending)

With this new NATIONAL Type B Dial, any ratio you desire, from a minimum of 6 to 1 to maximum of 20 to 1, is instantly obtained by shifting a small lever. It's marvelous how it separates stations. Has the same velvety smoothness, the same freedom from backlash as the National's popular Type A Dial. Easily mounted on the 1/4-inch shaft of any standard variable condenser.

*Get the Genuine. Insist upon NATIONAL COMPANY'S RADIO Products.
Your dealer appreciates your patronage and will gladly get them for you.*

NATIONAL COMPANY, Inc.

110 Brookline St.

W. A. READY, PRESIDENT

Cambridge, Mass.

The UNIVERSAL

Standards of Quality



Type 277-D

Coupling Coil
Price \$1.50

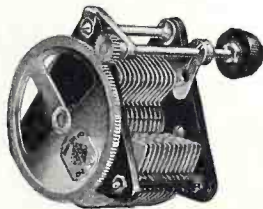

Type 247-H

Geared Condenser
Price \$5.00



Type 368

Micro-Condenser
Price \$1.25

In building a radio receiver, remember that its performance depends primarily upon two things: an efficient circuit, and the use of good parts.

Wherever you find a popular circuit you will invariably find General Radio parts.

The General Radio Company has contributed more in scientific apparatus for laboratory use than any other one Company in the history of radio. The same outstanding craftsmanship and materials are embodied in General Radio parts for use in the construction of broadcast receivers.

Through the merits of design, performance, and price, the General Radio instruments for the scientist or set-builder are universally recognized as the Standards of Quality.

Every instrument made by the General Radio Company is thoroughly guaranteed.

The General Radio Company has endeavored to make it possible for the experimenter to obtain its products with a minimum of effort. A careful selection of distributors and dealers has been made. They are best fitted to serve you. If, however, you are unable to obtain our products in your particular locality they will be delivered to you, postpaid, direct from the factory upon receipt of list price.

Write for Our Latest Parts
Catalog 924-C

GENERAL RADIO Co

CAMBRIDGE 39, MASS.



Type 285

Audio Transformer
6 to 1 and 2 to 1
Price \$6.00 Each



Type 301

Rheostat
12 Ohm and 25 Ohm
Price \$1.25



Type 349

UX-Tube Socket
Price 50c

GENERAL RADIO

INSTRUMENTS

“Behind the Panels of Better Built Sets”

Used in "BEST'S" Five-Tube Super



Write today
for FREE
Hook-Ups

AMPERITE

REG. U.S. PAT. OFF.

The "SELF-ADJUSTING" Rheostat

Insures Perfect Automatic Tube-Control
Because **AMPERITE**—

Sold Everywhere
\$1.10 complete
with mounting
(in U. S. A.)

- 1—Eliminates Hand Rheostats, thereby simplifying control.
- 2—Permits use of the latest types of tubes or any combination of tubes.
- 3—Simplifies and reduces set-wiring, thereby making for greater compactness and avoids losses.
- 4—No moving parts, hence no grinding noises; clear and full tones.
- 5—Prolongs tube-life by keeping filaments at a constant temperature.
- 6—No filament meters needed.
- 7—Brings the most out of each individual tube—automatically—no guessing.
- 8—Makes every set-owner a master operator, no knobs to turn.

For the new tubes:

Amperite No. 112—for the UX-112 and CX-112
Amperite No. 120—for the UX-120 and CX-120

Radiall Company

Dept. R-4 50 Franklin Street New York City

Be sure that the set you buy or
build is equipped with **AMPERITE**

Manufacturers of

TUNE-RITE
5% STRAIGHT LINE FREQUENCY DIAL

